

IVL™ Photon by MINUIT® UNE

Make the ordinary,
extraordinary.

An output for each moment

Goes with any kind of show

Standard daily-use

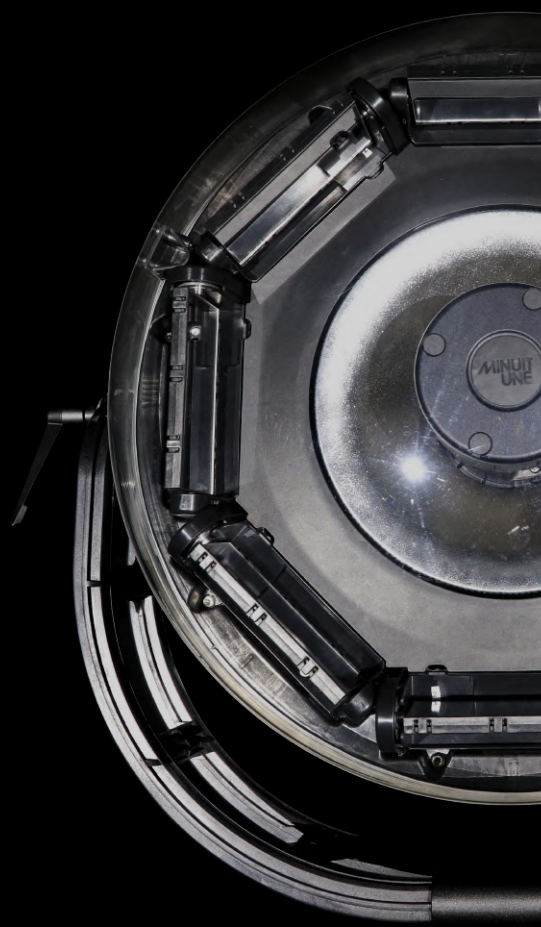

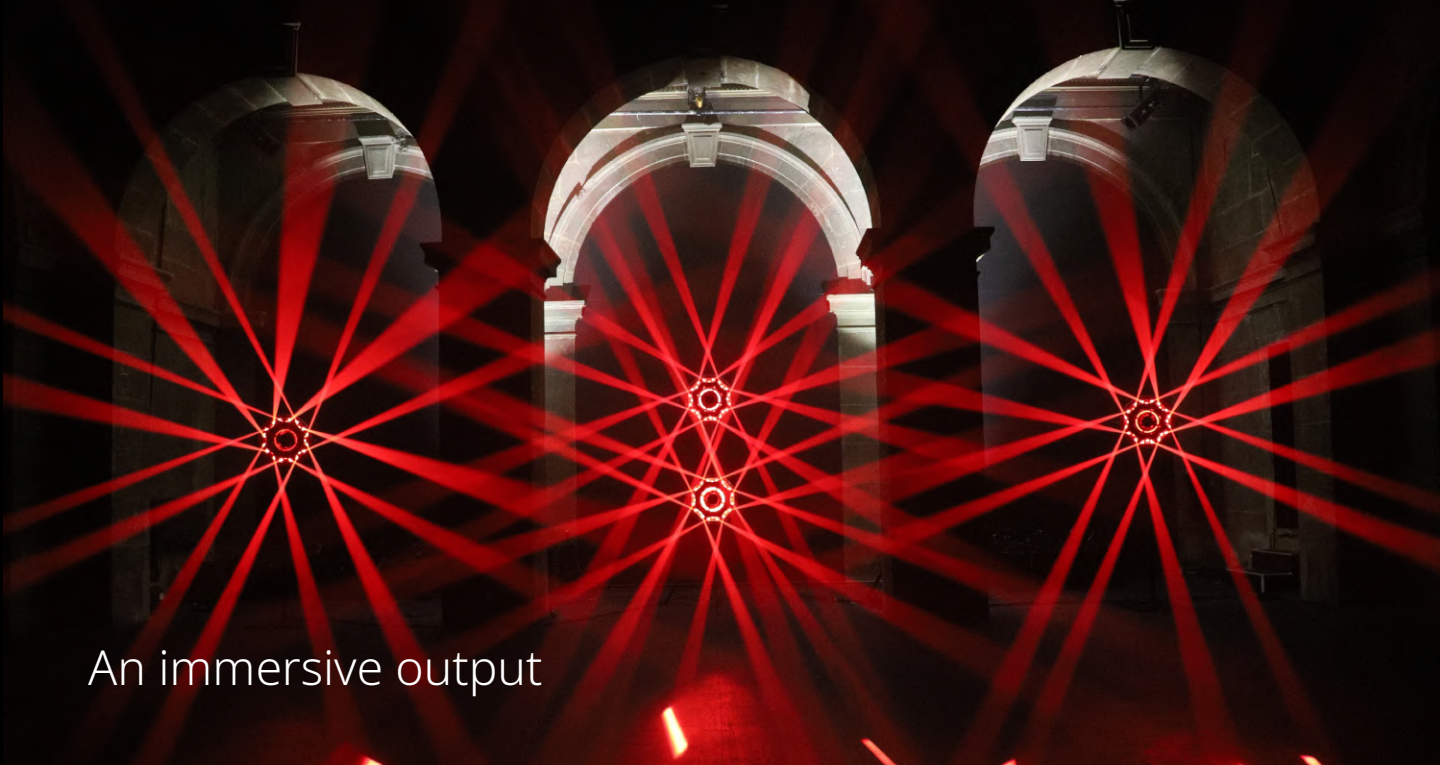

An immersive output

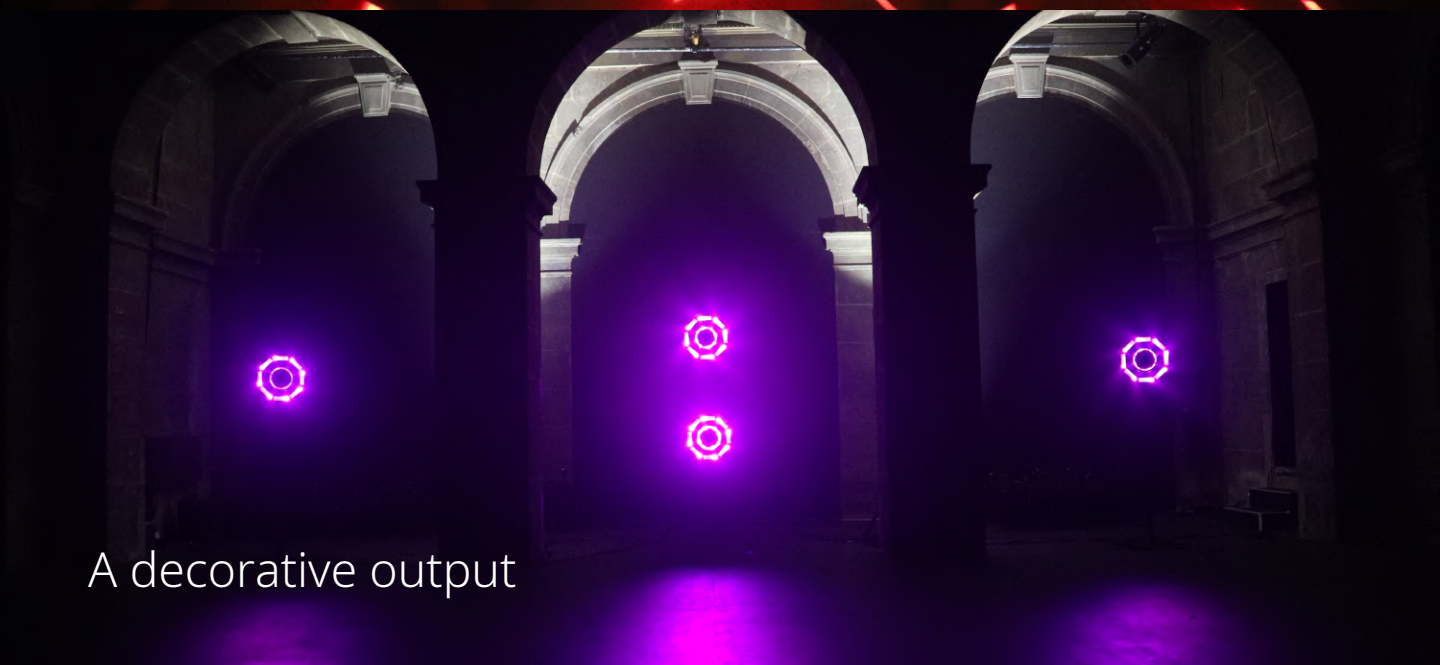

A decorative output



A creative punch

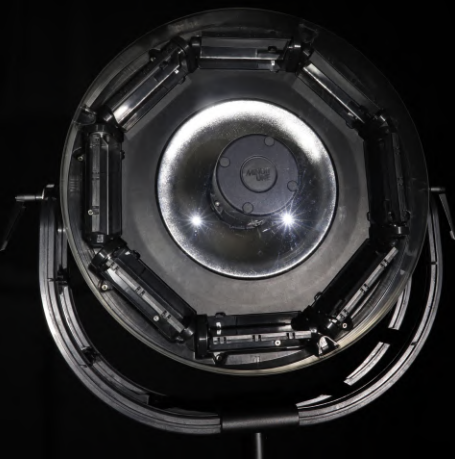

IVL™ Photon

by **MINUIT
UNE**

IVL Photon makes the ordinary, extraordinary

Lighting set-ups with many luminaires provide constantly renewed experiences during the whole show or event with decors, immersion, and advanced perspectives. Imagine now if it would be possible without having to use numerous fixtures. Imagine a luminaire allowing the widest range of atmospheres, on top of surprising the audience, starting with... a single unit. That is the IVL Photon. This technology-packed luminaire is the result of 5 years of R&D dedicated to giving smaller productions the magnitude of big arena experiences.

With its innovative moving core combined with the renowned 8 tilts system (2 sides by tilt, mirror and frost), the IVL Photon has 3 main outputs: immersive (mirror), decorative (frost) and creative punch (moving core).

A standard DMX control provides endless possibilities to customize the outputs to each moment: 9 gobos (creating from 1, 2, 4, 8, 16, 32, 64, 128 to 256 beams), dimmer and RGB control for each of the 8 mirror tilts, and an electronic shutter. Never had a luminaire allowed such a level of creativity while being so easy to use. IVL Photon can be incorporated into any kind of show or event thanks to its compact design, extreme versatility, and low logistics requirements.

Choosing the IVL Photon is proceeding to deliver quality and multiplicity while adding to extraordinary. It is exceeding the expectations without having to overdo and rely on the accumulation of less-versatile luminaires for the decorative and experiential part of lighting. In small and mid-sized venues, a few IVL Photons only already delivers the versatility needed: optimize your logistics and save on structures, transport, maintenance, time, power consumption and many other extra costs.

Choosing the IVL Photon is giving you the means to develop your notoriety.

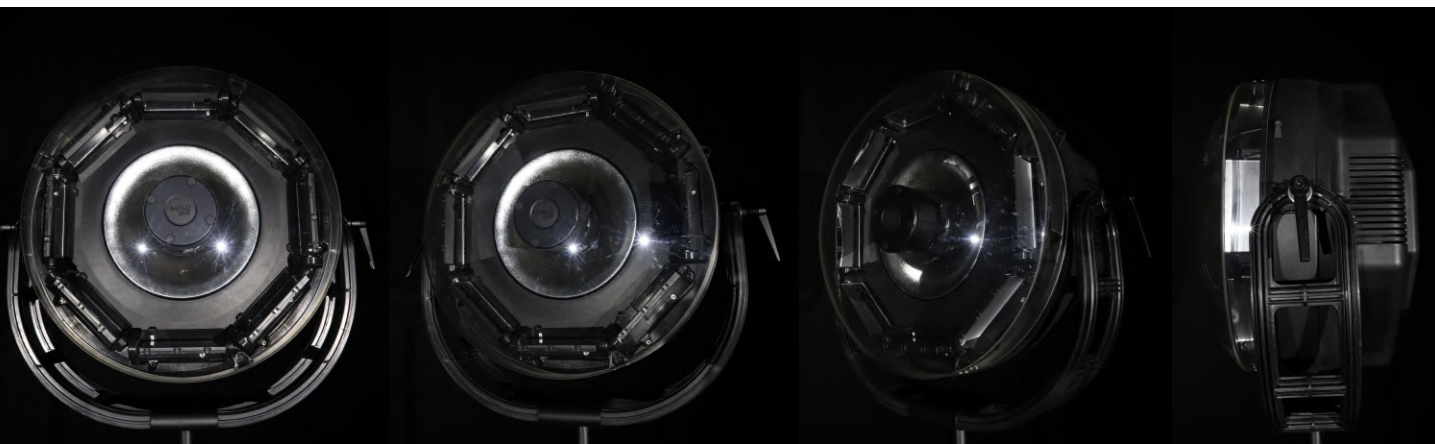



An immersive output



A decorative output



A creative punch

An output for each moment and much more

- o Deep perspectives for unforgettable immersive moments.
- o Decor highlights for transitional moments.
- o A creative punch for the brightest moments.

Each output is endlessly customizable thanks to the infinite range of possibilities offered by the DMX control: **a depth of looks and experiences never reached before, from classic to modern to outstanding.**

Goes with any kind of event

- o An easily incorporated design to deliver versatility in any show: music show, corporate event, aftershow, conference, club, broadcast, and many more.
- o Lightweight (16kg, 35lbs), compact (48cm diameter), low power consumption.
- o An adjustable handle for a quick set-up in any position.
- o An excellent RGB colorimetry.



A standard programming and daily use.

- An intuitive control, accessible to any lighting operator without training.
- 60 DMX channels offering the control over 9 gobos, the dimmer & RGB for each of the 8 tilts, a zoom to activate the moving core and an electronic shutter.
- A modular conception for low maintenance, fast repairs, and an extensive lifespan.
- Classified as Class 3R, IVL Photon is a laser-based lighting as safe as LED: it can be used in unsupervised areas according to the international standard (IEC 60825-3), without permit or specific training, and also variance-free in the USA.

ROI

- For rental companies, a pack of 6 IVL Photon is a smart investment that can be deployed in many events on a weekly basis, offering a higher satisfaction to customers for a reasonable price.
- For lighting designers, producers and event makers, a design based on IVL is a cost-effective, sustainable, and spectacular solution. Less fixtures needed, less logistics, less transport, and less power consumption: a real commitment for a lower carbon footprint.



3 IVL Photons on a stage of 12 meters wide

How does it work?

A lighting technology based on a laser-source, but NOT a laser effect, with unique outputs and textures

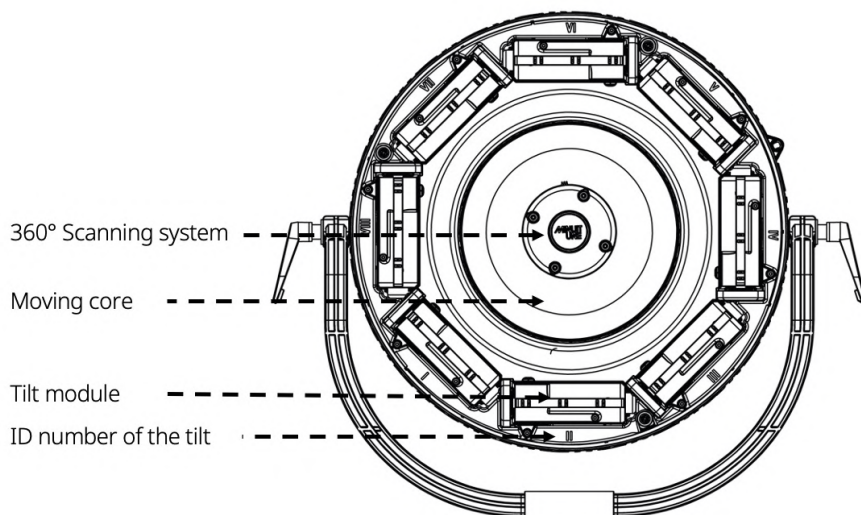

- o The failed-safe 360° scanning system, ensuring a constant very high frequency of rotation (>330Hz), produces a 360° light plan from the center to the 8 tilts .
- o The 8 surrounding tilts split the light into 8 **independent** light plans adjustable at 180° with 2 sides by tilt: mirror side and frost side. Thanks to advanced motorization, the tilts are extremely reactive, while extremely smooth at very low speed.
- o The moving core is a circular frosted reflector, located in the center of the product, that goes in and out, just like a zoom. A breakthrough innovation specially developed by Minit Une for the IVL Photon.

When the moving core is off, at position zero, it is down, retracted in the body of the fixture and the light goes from the center (scanning system) to the tilts (1).

When the moving core is on, it goes up, intercepts the light and provides a variable diameter of diffusion from large (2) to tight (3).

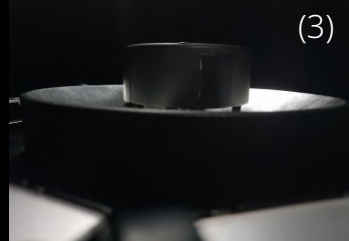
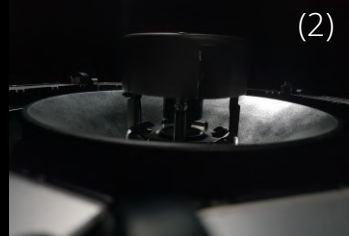
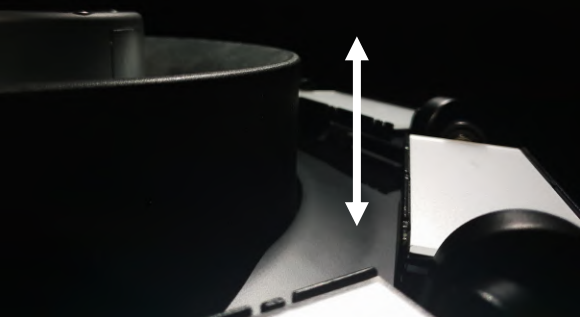

Mirror side of the 8 tilts

an immersive output

- Wide coverage & directive perspectives
 - 45° aperture by tilt
 - Calibrated for immersion in 500 to 5000 people venues
 - DMX control: tilt parameters on the console
ON for tilt values between 50% and 100%
- Shape the space with 3D perspectives or create special moments with the right haze and darkness levels: offer an unbelievable immersive thrill to your audience.

Frost side of the 8 tilts

a decorative output

- A very smooth diffused output
 - Adjustable at 180° - wide coverage
 - From frost to mirror in 0,25sec
 - 4 000 lux at the exit
 - DMX control: tilt parameters on the console
ON for tilt values between 0% to 50%
- Highlight your venue or your stage with an infinity of decorative possibilities. Great at any time, at any occasion.

Moving Core

a creative punch

- A concentrated and directive frosted output with a variable diameter of diffusion
 - Create a powerful ring of light from an audience perspective
 - 20 000 lux at the exit
 - DMX control: zoom parameter on the console
OFF for zoom values between 0% to 30%
ON for zoom values between 30% to 100%.
- The output for brightest moments, which can also be used as a background effect. Either an all-new kind of creative blinder or surprising stroboscopic effect.

Standard DMX Control

60 DMX channels for endless combinations

E-gobos control for beams programming with each output

9 e-gobos : 1, 2, 4, 8, 16, 32, 64, 128, 256 beams

Parameters: gobos size / gobos type / gobos rotation / gobos indexation

Controlling : width / number / speed of rotation / position of the beams

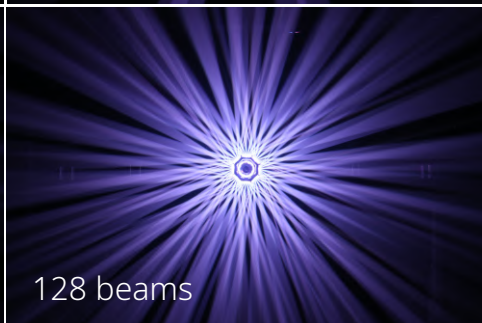
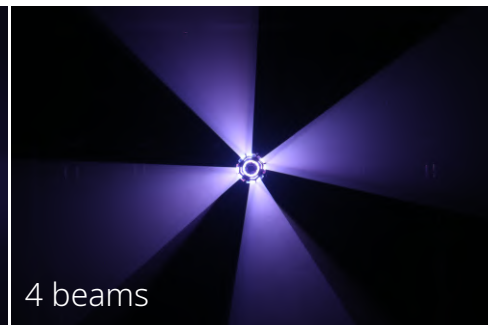
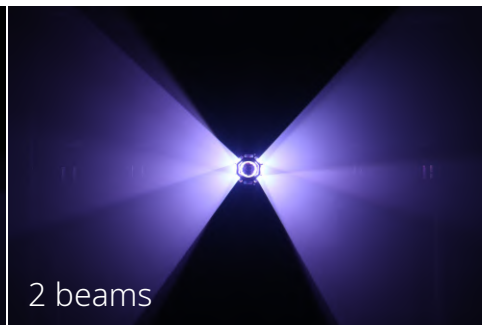
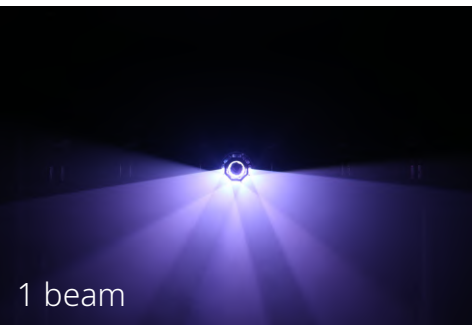

Independent controls allowed for each tilt:

- Position
- RGB
- Dimmer

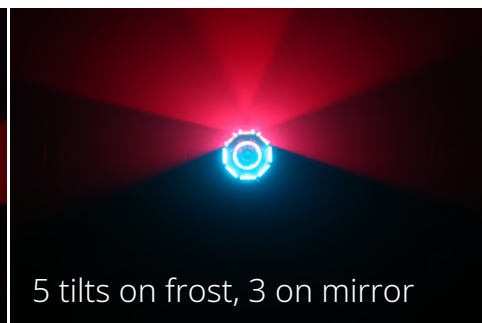
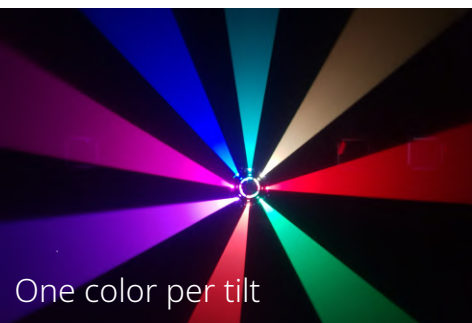

Easy to deploy and to maintain

- class 3R
- very easy to set up in any position
- 16 kg
- 48cm diameter
- <200W consumption
- 60 DMX channels
- LCD color screen
- RDM
- micro-SD card (software update)
- low cleaning
- very reliable
- long lifetime >10 000 hours
- easy to repair

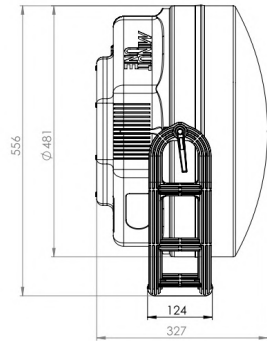
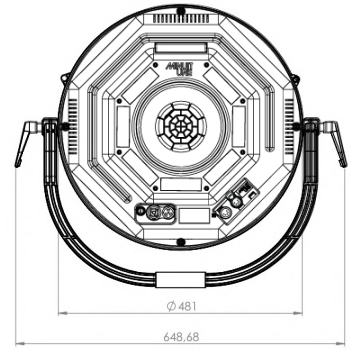

A modular conception

The IVL Photon has been designed with a modular conception: the fixture is subdivided into smaller parts, the modules, which can be independently replaced. Each module is designed to be “plug & play” when replaced.

- Save time: most of the repair operations are very fast, safe and easy. Replace the old module with the new one in less than 10 minutes.
- Increase the lifetime of your fixture: the easier it is to repair, the more sustainable it is.
- Save cost: instead of having spare fixtures with you (on tour for instance), bring the module suitcase with you.



Class 3R: as simple to operate as LED

IEC 60825-3 Guidance for laser displays and shows: “only laser products that are Class 1, Class 2 or visible-beam Class 3R should be used for demonstration, display or entertainment purposes in unsupervised areas.” “Laser products available for use by people who cannot be expected to have received a suitable level of training should be Class 1, Class 2 or visible beam Class 3R”.



Cost effective solution: a case study

A fact: today, most of the lighting fixtures are not used to properly light someone or something, but to produce an experience, with decor, perspectives & immersion.

Considering the fact that today's lighting fixtures are mostly mono-directional, it requires a certain number of fixtures and structures to answer the audience expectations. If an arena show has the budget, time and space for that, it is usually much more constrained in mid-sized venues.

In a mid-sized venue, the starting pack of luminaires is usually composed of only a few luminaires to actually light the artist and/or stage/or venue, as can be seen on the picture on the right. Then comes the lighting fixtures dedicated to "making the show" and telling the story of the spectacle or event:



Let's compare an IVL solution versus a "classic solution" for a 12m stage

With IVL Photon on stand

Typical Number of fixtures : 4
Weight: 64kg
Consumption: <800W
Decor: yes
Mid-air effects: yes
Advanced perspectives: yes
Immersion: yes
Time to set-up: <30min
Fits in a van : yes
Never-seen-before: yes

With less-versatile luminaire, as beams

Typical Number of fixtures : >16
Typical Weight: >160kg
Typical Consumption >3000W
Decor: not ideal
Mid-air effects: yes
Advanced perspectives: structures needed
Immersion: no
Time to set-up > 1 hour
Fits in a van: No
Never-seen-before: no

Choosing IVL instead of less-versatile luminaires it's:

- Bringing the extraordinary even with constrained means and logistics
- Saving on all the extra costs: time, weight and volume of transport, maintenance, power consumption, etc
- A real commitment to lower carbon footprint in live shows

Tips & Tricks !

The importance of the straight position while programming:

1) A key to impact

The closer you will be to the straight position of the tilts, the more you will benefit from the combination of their light plans. Creating tilt movement around the straight position can make the IVL Photon look up to 4 times more impactful and more immersive.

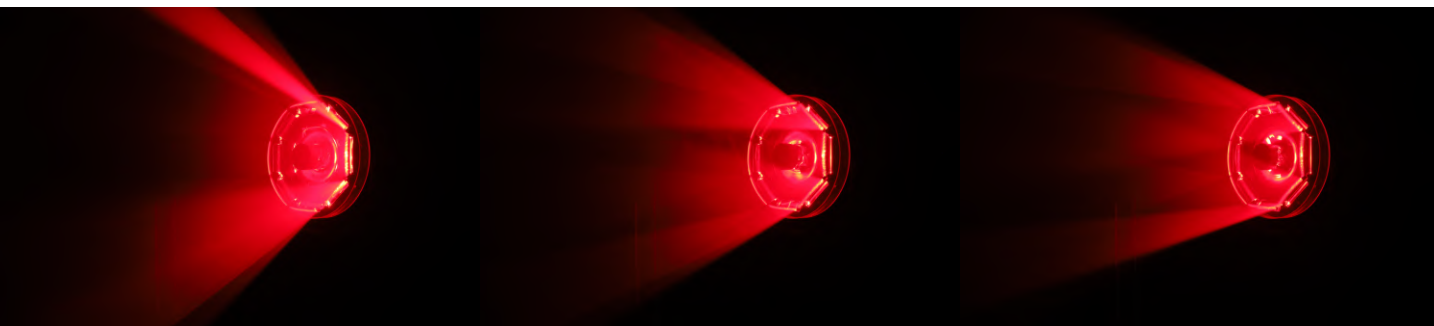
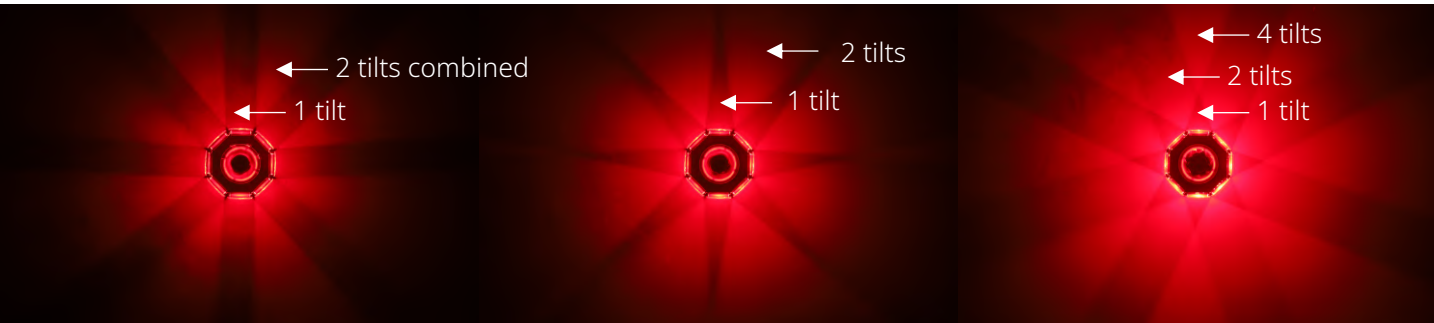

2) The widest coverage from an audience perspective

The more directive you are, the more space you cover. Being close to the tilt's straight position will optimize the space covered by the IVL Photon, from an audience perspective, thus having the full advantage of the 45° aperture per tilt.



3) Optimal coverage

To optimize the creation of immersive perspectives, an IVL Photon placed every 2/3 meters on stage for example, can be a good reference



Achieve a different type of dimmer with the e-gobo size

Of course you can always dim the fixture with the standard dimmer channels, however this "intensity" dimmer will be slightly cut at the beginning due to the laser-based nature of the source.

Another way to dim the fixture more smoothly is by reducing the value of the e-gobo size: This way, it will black-out the fixture by reducing the aperture of the light output. It is especially interesting when combined with the moving core.

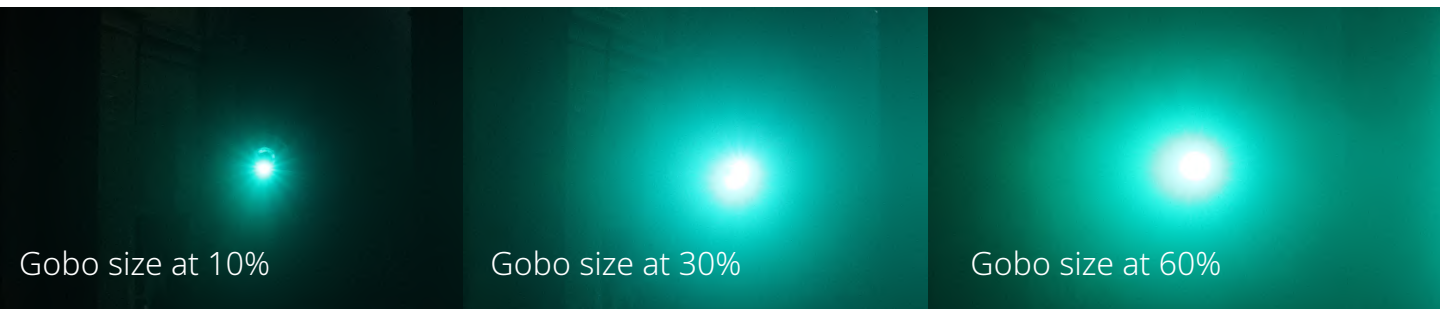

Support

Quick- start show files

Developed by our support team, an IVL Quick-start show file is an advanced library, available for most of the DMX consoles. Presets, tilts movements, layout: all the basics are already programmed.

- o a very powerful tool to save your time
- o A great starting point to go further and customize your own cues.

Download: <https://minuitune.com/ivl-support/>

Online demo

Take part in a videoconference session with our sales team with a live connection from our showroom to get an advanced presentation of our product and ask all your questions.

A project in mind?

You have a project in mind, and you would like to know how to optimize your budget? Where to find the IVL Photon? Have some special technical requests?

Let us help you !

Our team is dedicated to helping you. Contact us at contact@minuitune.com



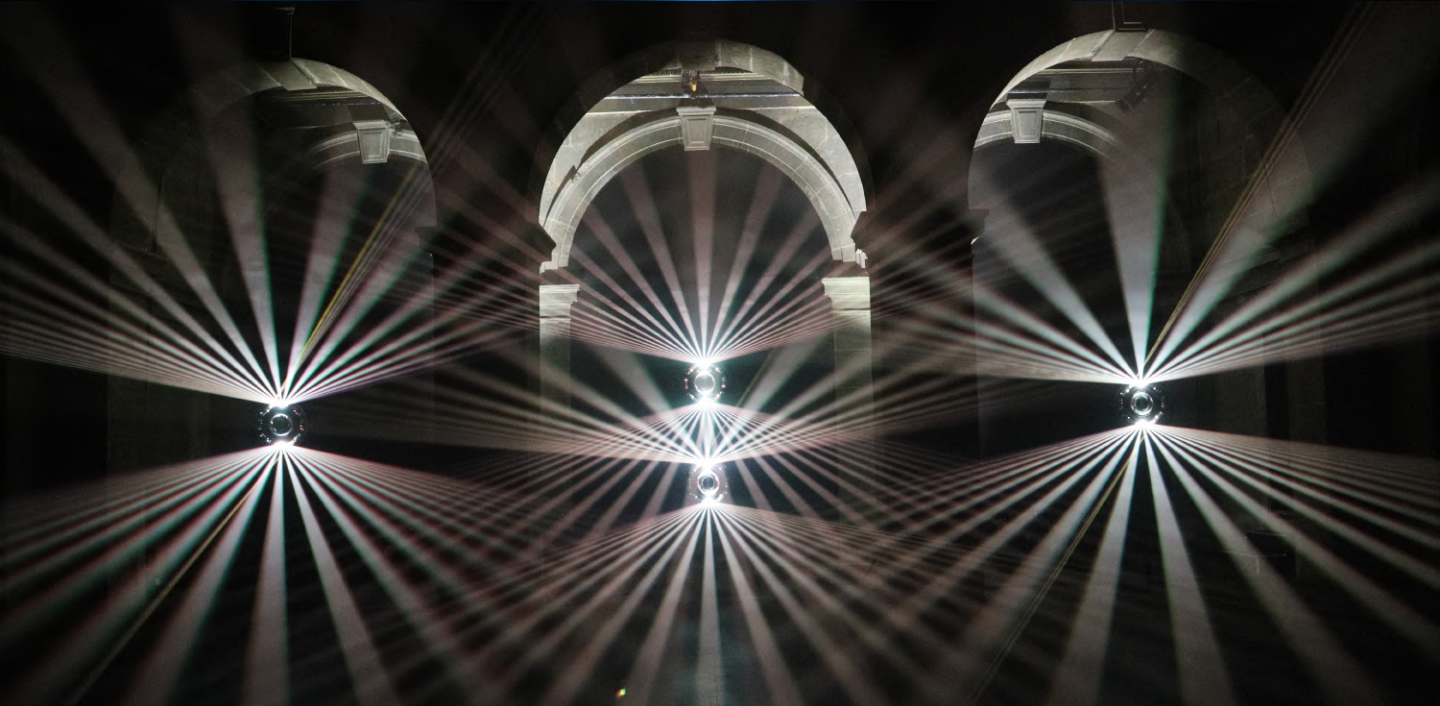

MINUIT[®]
UNE

www.minitune.com