

Lupo
Made in Italy

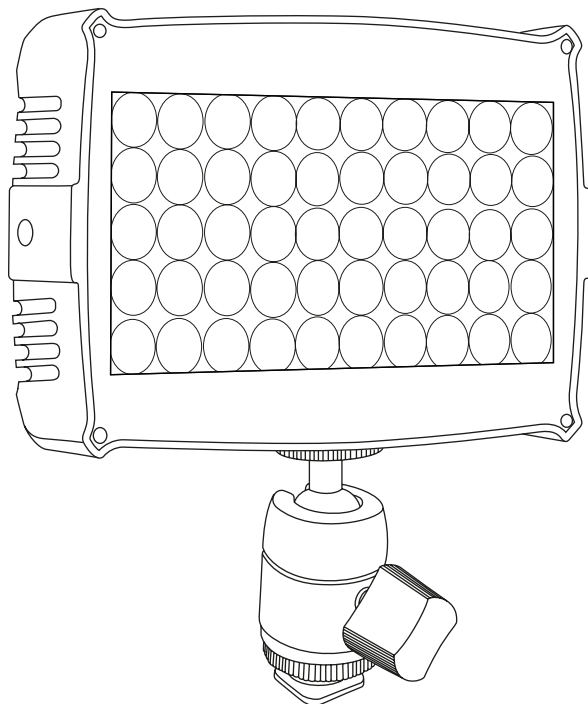

Smartpanel DUAL COLOR PRO

User Manual

Release 4.xx

SAFETY PRECAUTIONS:

Do not operate the equipment before studying the instruction manual and the accompanying safety precautions. Make sure that Lupo Safety Instruction is always included with the equipment! Lupo products are intended for professional use. Do not place or use the equipment where it can be exposed to moisture, extreme electromagnetic fields or in areas with flammable gases or dust! Do not expose the equipment to hasty temperature changes in humid condition as could lead to condensation water in the unit. Equipment must only be serviced, modified or repaired by authorized. Dealers or the factory.

CAUTION - BURN HAZARD - HOT PARTS

Do not touch hot parts with bare fingers! LED bulbs and certain metal parts emit strong heat when used!

Do not point lamps too close to persons. Always use the fixtures with the front part closed.

NOTICE - EQUIPMENT OVERHEATING RISK

Do not obstruct ventilation by placing filters, diffusing materials, etc. over inlets and outlets of the equipment ventilation or directly over glass cover or LED bulbs.

FINAL DISPOSAL

Equipment contains electrical and electronic components that could be harmful to the environment.

Equipment may be returned to Lupo distributors free of charge for recycling

according to WEEE. Follow local legal requirements for separate disposal of waste, for instance WEEE directive for electrical and electronic equipment on the European market, when product life has ended.

MAINTENANCE AND CARE

Please do not forget that the safe operation of lampheads also includes their maintenance and care.

A visual inspection should be conducted before every use and an inspection of electrical safety should be conducted at least once every 12 months.

WARRANTY

The warranty period for Lupo products and those marketed by Lupo is twelve months from the date of delivery. Lupo guarantees that the goods it supplies are well manufactured and of good quality. The warranty guarantees the repair of any parts that show acknowledged defects in materials, construction or workmanship during the warranty period. The guarantee excludes any liability for direct or indirect damage of any kind and for any reason, for which Lupo will therefore not be required to pay compensation. The customers shall see to delivering the parts that need repair or replacement to Lupo's works at their own expense and risk. The repaired or replacement parts shall be delivered by Lupo ex-works. The customers will be charged for materials and labor or replacement of the product after the expiration of the warranty period.

*Thanks for having purchased **Lupo** products. All the products are made in Italy and all the efforts have been put to keep the quality standards high. We hope this product can help you in your job and make your life easier as a professional. We also hope you will enjoy its use and we would be happy to receive your feedback about it.*

Instructions

- Device for indoor use only.
- Maximum ambient temperature: 40 °C.
- Make sure power supply plug is suitable for power required.
- To switch on the light push the on/off button.
- Smartpanel Dual Color PRO model are equipped with new generation high quality powerleds.

ATTENTION: when the C type cable is connected, and the unity is powered by Type C cable, the power is 50%.

Package Contents

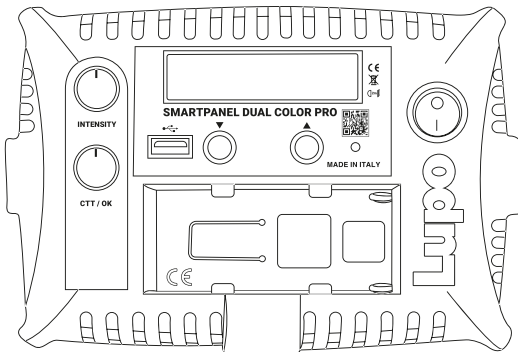

Smartpanel Dual Color PRO

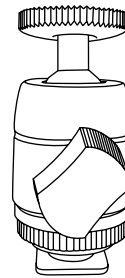

Stand and camera adapter

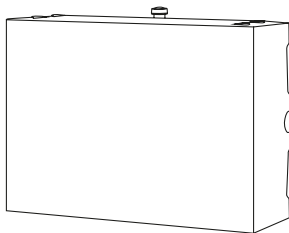

Diffuser

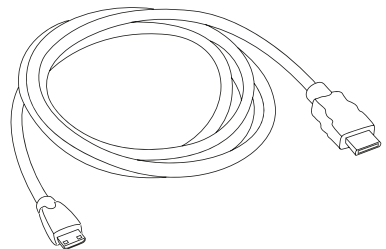

USB cable

Switching on the Smartpanel Dual Color PRO

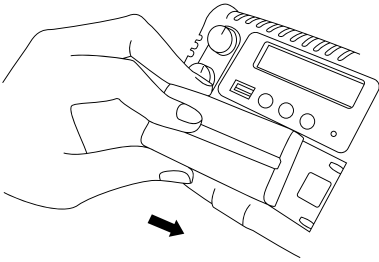

1 For battery use:
insert the battery (not included) and switch ON the unit.

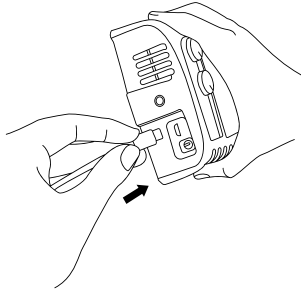

2 For use with USB cable: insert the USB cable in the USB port and switch ON the unit.
Power supply only min 2A

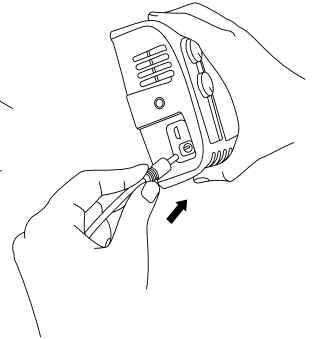

3 For use with DC Adapter Connection: insert the Adapter Connection in the DC port and switch ON the unit.

Getting Started

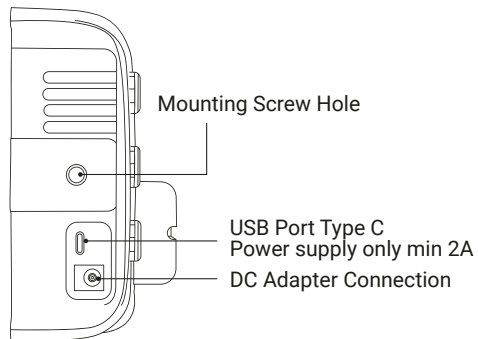
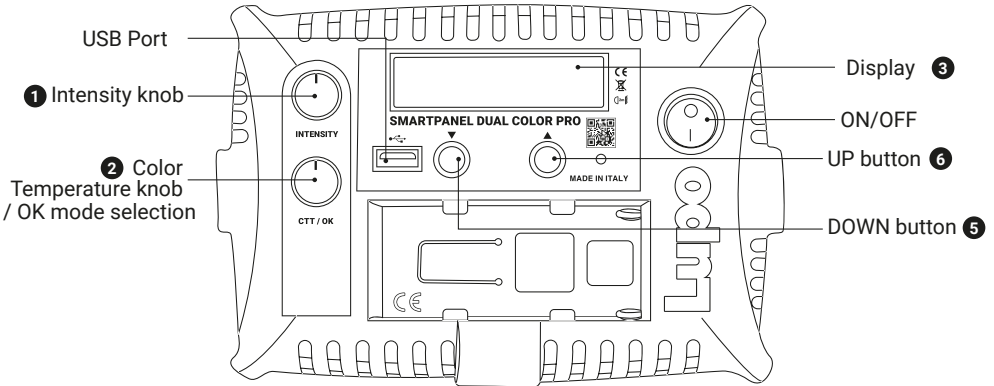

CONTROL PANEL

- In current mode press the « OK » ② knob to enter the main MENU.
- In the sub-menu press the « OK » ② knob to confirm a selection.
- Rotate the ② knob to navigate in the main MENU and sub-menus.
- Use the « INTENSITY » ① knob to adjust the **light intensity from 0 to 100%**.
- Use the knobs ⑤ and ⑥ to adjust the light mode parameters.
- Display ③.

MANUAL OPERATION

1. Press the « OK » ② button to enter the main MENU.
2. Select **MANUAL** by pressing the « OK » ② button.
3. Select the light mode between **CCT MODE**: pressing the « ▲ » ⑥ button, rotate the ② knob to change the frequency.

LIGHT MODES

MODE	INTENSITY ④	CCT ②	Rotate ② Knob
CCT	Light Intensity from 0 to 100%	CT 3200K to 5600K	-
EFFECT		"See EFFECT table"	Change Effect

A. CCT MODE: Warm and cold white control mode. It allows you to adjust colour temperature (CCT), and light intensity. *The STROBE effect is the default setting.*

- In CCT Mode, the « ▲ » key selects the STROBE page and the « ▼ » key exits the STROBE PAGE.
- In the STROBE PAGE it is possible to set DIMMER value with the ① knob and the STROBE frequency by rotating the ② knob. The Frequency is 1 to 25 Hz.

ATTENTION: STROBE frequency = 0 means **STROBE** effect OFF.

B. SPECIAL EFFECT MODE: Mode with 3 SPECIAL EFFECTS. **TELEVISION / PAPARAZZI / LIGHTNING.**

1. In MANUAL OPTIONS menu select **EFFECT MODE**.
2. Select the EFFECT to be activated with rotating ② knob, confirm the selection by pressing the « OK » ② knob.
3. In current mode, change the EFFECT in ascending or descending order by rotating the ② knob. **THE EFFECT ON THE DISPLAY IS THE SELECTED EFFECT.**
4. Use the buttons ⑤ and ⑥ and the ② knob to adjust the effect setting values. **See table below.**

⚠ ATTENTION - Only to STROBE effect

1. The strobe effect is applied to the parameters of the last configured CCT mode.
2. The STROBE effect is **NOT WORK** if TELEVISION, PAPARAZZI or LIGHTNING effects are in functioning.

EFFECT	① INTENSITY knob	② CCT knob	« ▼ » ⑤ OR « ▲ » ⑥
TELEVISION	Light Intensity from 0 to 100%	White range - 1 / 2 / 3 / 4	Frequency - 4 to 24 Hz
PAPARAZZI		Flashing Interval - 1 to 10	Bulb type - 0 / 1 / 2
LIGHTNING		Color Temperature	Lightnings Interval - 1 to 20

BLUETOOTH

1. Rotate and press the « **OK** » ② knob to enter the BLUETOOTH MENU.
2. Rotate and press the « **OK** » ② knob to ON / OFF the BLE functions.

DEVICE SETTINGS

1. Press the « **OK** » ② knob to enter the main MENU.
2. Navigate through the **DISPLAY OPTION / FREQUENCY / FILTER / LINEARIZATION** functions, rotating the ② knob to select the desired function and press « **OK** » ② knob to confirm the selection.

Display: Time during which the display backlight stays on. **30sec / 1min / ALWAYS ON.**

Frequency: 18Khz / 25 Khz

Filter: It is the speed response of the system (smooth factor).

FULL SPEED / NORMAL SPEED / HIGH SPEED / LOW SPEED.

Linearization: Linearization is the compensation curve for the human eye's perception of the luminous intensity emitted as a function of the required power. Required power = dimmer value on the display. **LINEAR / EXPONENTIAL / LOGARITHMIC.**

Linear: No compensation, the intensity of the light is directly proportional to requested power.

Exponential: The light intensity increases from 0 to 100 exponentially.

Logarithmic: The light intensity increases from 0 to 100 logarithmically.

RESET DEVICE

1. Press the « **OK** » ② knob to enter the main MENU.
2. Select **RESET DEVICE** rotating the ② knob, press the « **OK** » ② knob to confirm the selection.
3. Select **YES** rotating the ② knob, press « **OK** » ② knob to confirm the selection.
4. The device will ask for further confirmation, select **YES** by pressing the « **OK** » ② knob. **THE DEVICE WILL RETURN TO FACTORY DEFAULT SETTINGS.**

FACTORY DEFAULT SETTING

MANUAL OPERATION

MODE: CCT

DEVICE SETTINGS

DISPLAY: 1 min

FILTER : Normal speed

LINEARIZATION: Linear

INFO

1. Rotate and press the « **OK** » ② knob to enter the INFO MENU.
Here you can find the firmware informations.

Update the Firmware

1. Copy the file on an USB Pendrive (FAT32 formatted) in the main root;
2. Switch off the equipment and insert the USB Pendrive;
3. Switch on the equipment;
4. Wait until display backlight flashes (it takes several minutes and red led must toggle for all time long);
5. Switch off the equipment;
6. Extract the Pendrive and switch on the equipment: the firmware is updated.

MENU e submenus

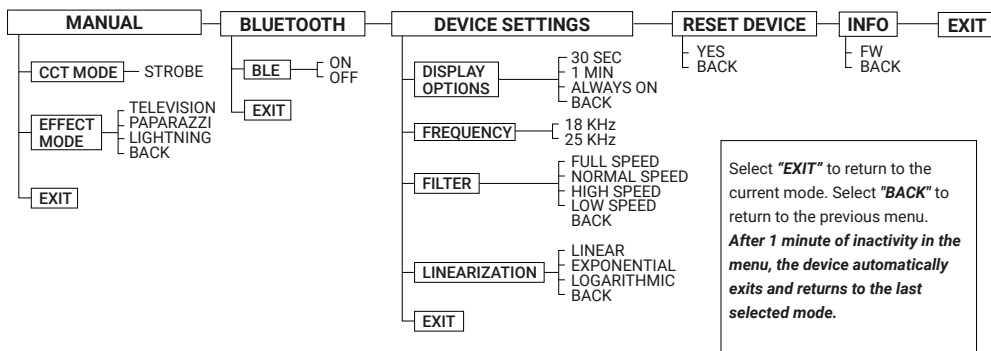

Accessories

The accessories are products sold separately.

2



2 Battery

Battery option 1: NP-F-SERIES (7.4 V)

Battery option 2: V-Mount type (14.8 V)

3

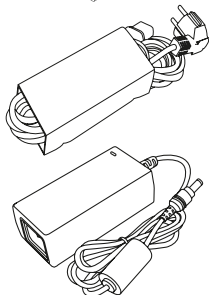

3 AC Power Cord Cable and AC Adapter (cod. 752)

AC input: 100 V - 240 V DC output: 24 V

Attention: DC center pin must be positive.