

# Studio Due<sup>®</sup>

emotion and creativity in light

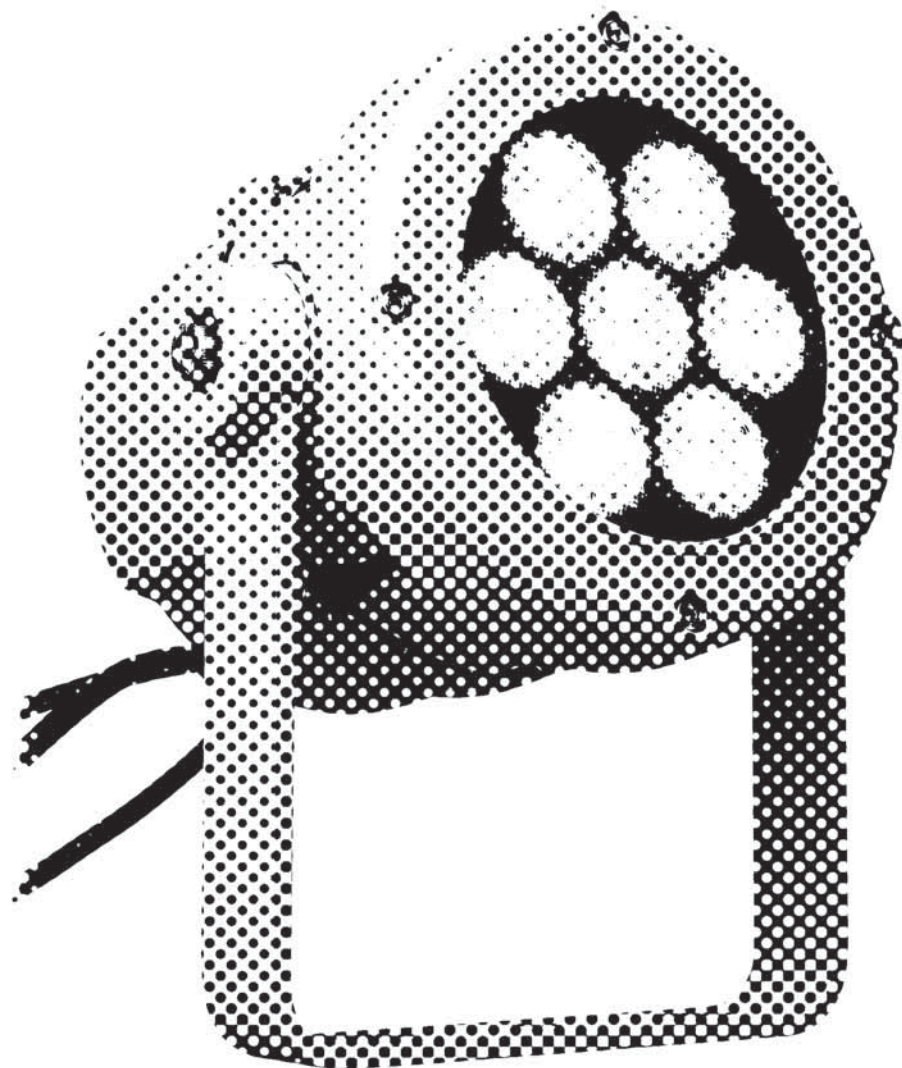

**ParLED<sup>100</sup>**

**User manual for art. 1506-1507-1508-1509  
Manuale d'uso per art. 1506-1507-1508-1509**

this page is intentionally left blank / questa pagina è stata lasciata intenzionalmente bianca

## 4 PIN connector - Connettore 4 PIN

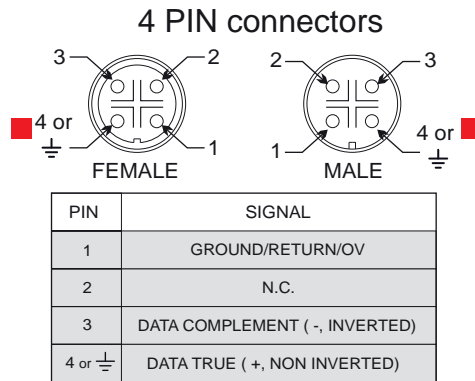

**WARNING**  
**IMPORTANTE**

In this connector you can find the NUMBER 4 or the GROUND sign.

In questo connettore potete trovare il NUMERO 4 o il simbolo della TERRA.

**IMPORTANTE**  **WARNING**

**endowed with the fixture - incluso nell'apparecchio**

If you want to connect the fixtures for **OUTDOOR** use, you can make a new cable utilizing the **art. 4 PIN-CONN M/F**

The cable is not endowed with the connectors kit

**art. 4 PIN-CONN M/F**



Se volete utilizzare gli apparecchi all'**ESTERNO**, potete realizzare dei nuovi cavi con **art. 4 PIN-CONN M/F**

Il cavo non è incluso nel kit dei connettori

**optional - opzionale**



**art. 4 PIN/XLR MF (OPTIONAL)**

these **CONNECTORS** are for **INDOOR** use only

questi connettori sono solo per uso **INTERNO**

**INDOOR USE ONLY**

art. 4 PIN/XLR MF male/female connectors (optional)

art. 4 PIN/XLR MF connettori maschio/femmina (opzionale)

these **CONNECTORS** are **IP67**

questi connettori sono **IP67**

## INDEX

Page 4 - Safety informations / Informazioni di sicurezza

Page 5 - Introduction / Introduzione

Page 6 - Technical features / Caratteristiche tecniche

Page 7 - Example of connection DMX controller-fixtures / Esempio di collegamento centralina DMX-fari

Page 8 - Main supply connection / Collegamento fonte di alimentazione

Page 9 - DMX signal connection / Collegamento segnale DMX

Page 10 - DRS functioning / Funzionamento del DRS

Page 11 - Control panel functions / Funzioni del pannello di controllo

Page 15 - DMX Listing / Lista dei canali DMX

Page 18 - Built in programs / Lista dei giochi

Page 19 - Physical / Dimensioni

Page 20 - CE standards / Certificazioni CE

Page 21 - Warranty / Garanzia



RGBW/Full Color

art. 1506 - Parled 100/FC  
art. 1507 - Parled 100/FC DRS



Monochromatic

art. 1508 - Parled 100/M  
art. 1509 - Parled 100/M DRS

**WARNING****SAFETY INFORMATION (service personnel)**

READ ALL CAUTIONS AND WARNINGS PRIOR TO OPERATE THIS EQUIPMENT.  
INSTRUCTION TO PREVENT INJURY OR DAMAGE DUE TO ELECTRIC SHOCK, FIRE, MECHANICAL HAZARDS,  
DANGEROUS MATTERS.

**•PROTECTION AGAINST DANGEROUS MATTERS**

At the end of its life, must be collected separately. It shouldn't be thrown as urban waste and neither released in the environment.

It must be collected from the nearest special waste collection point or consigned to your dealer that provides the service. The incorrect waste disposal can damage the environment and the people for the presence of dangerous substances. Sanctions are provided for an unauthorized disposal.

**•PROTECTION AGAINST FIRE**

- 1) Maintain minimum distance of 0.2 meter from walls or any other type flammable surfaces.
- 2) Maintain minimum distance of 0,2 meter to lighted objects .
- 3) Replace fuses (if present) only with the specified type and rating.
- 4) Do not install the fixture close to heat sources. Do not lay the connection cable on the fixture when it is warm.
- 5) Fixture designed to be installed on normally flammable surfaces.

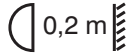
**•PROTECTION AGAINST ELECTRIC SHOCK**

- 1) **This equipment must be earthed.**
- 2) Class I equipment. The power supply cord includes a protective earthing conductor as part of the cord.
- 3) Disconnect power before servicing (service personnel).

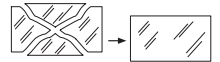
**•PROTECTION AGAINST MECHANICAL HAZARDS**

- 1) Use secondary safety chain when fixing this equipment.
- 2) Equipment surface may reach temperature up to 75°C.
- 3) The protection screens and the lenses must be replaced with genuine parts only if they are visibly damaged and their effectiveness has been reduced, for example, by cracks or deep scratches.

**IMPORTANTE****INFORMAZIONI DI SICUREZZA (personale di servizio)**

LEGGERE ATTENTAMENTE TUTTI GLI AVVERTIMENTI PRIMA DI COMPIERE QUALUNQUE OPERAZIONE SU QUESTO APPARECCHIO. ISTRUZIONI PER PREVENIRE LESIONI O DANNI DOVUTI AL FUOCO, ALLE SCOSSE ELETTRICHE, AI RISCHI MECCANICI ED A SOSTANZE PERICOLOSE.

**•PROTEZIONE CONTRO SOSTANZE PERICOLOSE**

A fine vita è oggetto di raccolta separata, non gettare nei comuni cassonetti di rifiuti urbani, né tantomeno nell'ambiente. Può essere consegnato presso gli appositi centri di raccolta differenziata predisposti dalle amministrazioni comunali, oppure presso i rivenditori che forniscono questo servizio. Lo smaltimento errato può causare danni alle persone e all'ambiente per la possibile presenza di sostanze pericolose. Sono previste sanzioni in caso di smaltimento abusivo dei suddetti prodotti.

**•PROTEZIONE CONTRO IL FUOCO**

- 1) Mantenere la distanza minima di 0.2 metri da pareti ed altre superfici infiammabili.
- 2) Mantenere la distanza minima di 0,2 metri dagli oggetti illuminati.
- 3) Sostituire i fusibili (se presenti) solo con altri dello stesso tipo e valore.
- 4) Non installare il faro vicino fonti di calore. Non appoggiare il cavo di connessione sul faro quando questo è caldo.
- 5) Questo apparecchio è adatto per il montaggio su superfici normalmente infiammabili.

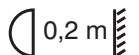
**•PROTEZIONE CONTRO SCOSSE ELETTRICHE**

- 1) **Questo apparecchio necessita di messa a terra.**
- 2) Apparecchio di Classe I. Il conduttore di protezione deve far parte del cavo di alimentazione.
- 3) Disconnettere l'alimentazione prima di aprire l'apparecchio (personale di servizio).

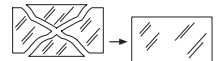
**•PROTEZIONE CONTRO RISCHI MECCANICI**

- 1) Usare la catena di sicurezza supplementare quando installate il faro.
- 2) La temperatura dell'apparecchio può raggiungere 75°C.
- 3) Gli schermi di protezione e le lenti devono essere sostituiti sempre con ricambi originali se sono visibilmente danneggiati e se la loro efficacia è stata ridotta, per esempio, da fessure o incisioni profonde.



**INTRODUCTION**

Thanks for using Parled 100.

The PARLED 100 is our new IP67 compact spot. Available in four version RGBW and Monochromatic. The robust design of the fixture is fully die-cast aluminum. High light output and spectacular effects are the key drivers of the fixture. Standard fixture colour finishing is grey.

- **Art. 1506 Parled 100/FC (rgbw full color)**
- **Art. 1507 Parled 100/FC DRS (rgbw full color)**
- **Art. 1508 Parled 100/M (monochromatic)**
- **Art. 1509 Parled 100/M DRS (monochromatic)**

To obtain the best performances and for a correct functioning of this unit for the years to come, we suggest you to read carefully this manual before connecting or putting the fixture into use. By doing so you will gain experience with its commands and connections and you will be easily able to use it.

**YOUR REFERENCE**

Always remember to give the serial number and to specify the model any time you address the seller for information or assistance.

**BASIC KIT**

- Projector
- 2 AMPHENOL connectors 4 pin male and female (without cable depending on the model)
- User manual
- Studio Due warranty
- CE standards

**WARNING**

**Check that the fixture has not been damaged during transport. If it has been damaged or it does not work, address the seller. Whether the fixture has been shipped to you directly, please contact the shipping company. Only the consignee (person or company) can claim for these damages.**

**INTRODUZIONE**

Vi ringraziamo per l' utilizzo del nostro Parled 100.

Il PARLED 100 è il nostro nuovo spot compatto IP67. Disconibile in quattro versioni RGBW e Monocromatico. Apparecchio compatto e robusto in alluminio pressofuso. Alta luminosità ed effetti spettacolari sono i fattori chiave del dispositivo. La finitura standard è grigio.

- **Art. 1506 Parled 100/FC (rgbw full color)**
- **Art. 1507 Parled 100/FC DRS (rgbw full color)**
- **Art. 1508 Parled 100/M (monochromatic)**
- **Art. 1509 Parled 100/M DRS (monochromatic)**

Per ottenere il meglio delle prestazioni ed un corretto funzionamento negli anni di questa unità, Vi consigliamo di leggere attentamente questo manuale prima di collegarla e metterla in uso. In questo modo acquisirete familiarità con i suoi comandi e collegamenti affinché possiate utilizzarla facilmente.

**VOSTRA REFERENZA**

Citate sempre il numero del modello e di serie ogni volta che Vi rivolgete al vostro rivenditore per informazioni o assistenza.

**CONFEZIONE BASE**

- Proiettore
- 2 connettori AMPHENOL a 4 pin maschio e femmina (senza cavo in base al modello)
- Manuale d'uso
- Garanzia Studio Due
- Dichiarazione CE

**IMPORTANTE**

**Controllate che l'apparecchio non abbia subito alcun danno durante il trasporto.  
Se avesse subito dei danni o se non dovesse funzionare, rivolgetevi al vostro rivenditore.  
Se l'apparecchio vi è stato spedito direttamente, rivolgetevi subito alla ditta di trasporto.  
Solo il destinatario (la persona o ditta ricevente l'apparecchio) può reclamare per questo tipo di danni.**



art. 1506  
art. 1507



art. 1508  
art. 1509

**• SOURCE**

n. 7 RGBW/FC LEDs  
Total out lumen:  
Red 550lm, Green 1000lm, Blue 180lm, White 1200lm

**• OPTIC**

25° standard beam (32mm lenses)  
On request: narrow, wide (32mm lenses)

**• TILT**

Manual 360°

**• CONTROL**

Standard interface: RS-485  
Protocol: USITT DMX 512

**• CONNECTIONS**

Signal: XRL 5pin (on request 3pin) male-female connector (art. 1506)  
4pin IP 67 male-female connector (art. 1507)  
Main Power: 3x1mm cable

**• SETUP AND CONFIGURATION**

Control panel with 4 push buttons (art. 1506 only)  
LED display with flip function (art. 1506 only)  
Remote configuration by DRS Setup device  
Dedicated DMX channel for white balance  
DMX or automatic mode with MASTER/SLAVE function  
Intelligent temperature control  
Flicker free function  
Smooth dimming function  
Halogen simulation  
CYM emulation

**• SAFETY**

eyebolts for safety chain

**• IP 67 RATING PROTECTION (art. 1507)**

**• IP 20 RATING PROTECTION (art. 1506)**

**• POWER SUPPLY**

Voltage range: 100-240VAC  
Frequency range: 47-63Hz  
Active Power factor:  
PF>0.91/230VAC, PF>0.98/120VAC  
Current: 0.22A@230VAC, 0.38A@120V  
Power: 45W

**• DMX CHANNELS**

- 9 ch mode  
- 5 ch mode  
- 4 ch mode

**• PHYSICAL**

WxDxH: 185x140x230mm  
Weight: 2 Kg.

**• SOURCE**

n. 7 high power 5000K White LEDs  
Total out lumen: 4000lm (white LEDs 5000K)  
Total light power: 34W

On request:

3000K, 4000K, 6000K white LEDs or  
red, green, blue, amber LEDs

**• OPTIC**

25° standard beam (32mm lenses)  
On request: narrow, wide (32mm lenses)

**• TILT**

Manual 360°

**• CONNECTIONS**

Signal: 4pin IP 67 male-female connector (art. 1509 only)  
3x1mm 1.5mt cable

**• SETUP AND CONFIGURATION (art. 1509 only)**

Remote configuration by DRS Setup device  
Intelligent temperature control  
Flicker free function  
Smooth dimming function  
Halogen simulation

**• SAFETY**

eyebolts for safety chain

**• IP 67 RATING PROTECTION**

**• POWER SUPPLY**

Voltage range: 100-240VAC  
Frequency range: 47-63Hz  
Active Power factor:  
PF>0.90/230VAC, PF>0.98/120VAC  
Current: 0.2A@230VAC, 0.3A@120V  
Power: 38W

**• DMX CHANNELS (art. 1509 only)**

- 3 ch mode  
- 1 ch mode

**• PHYSICAL**

WxDxH: 185x140x230mm  
Weight: 2 Kg.

## EXAMPLE OF CONNECTION DMX CONTROLLER - FIXTURES / ESEMPIO DI COLLEGAMENTO CENTRALINA - FARI

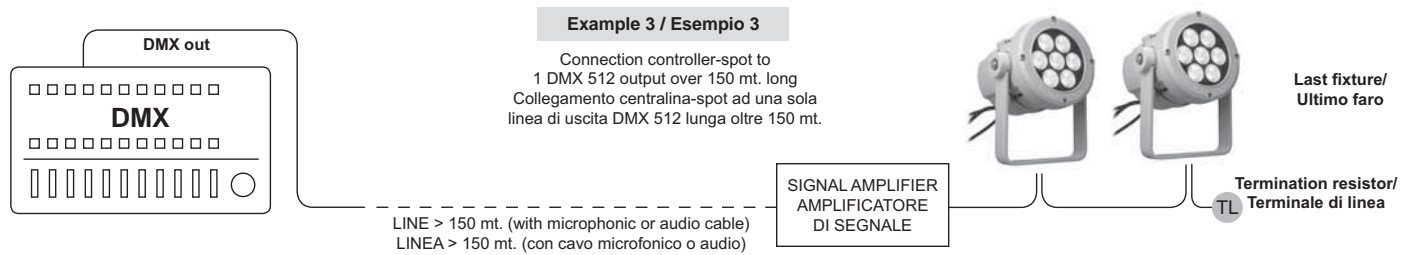
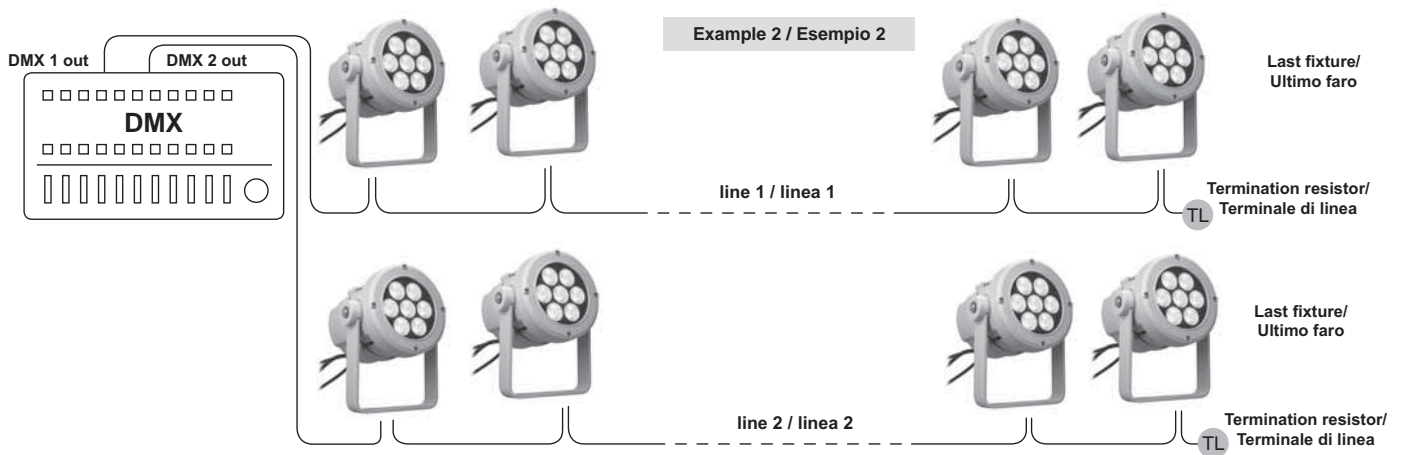
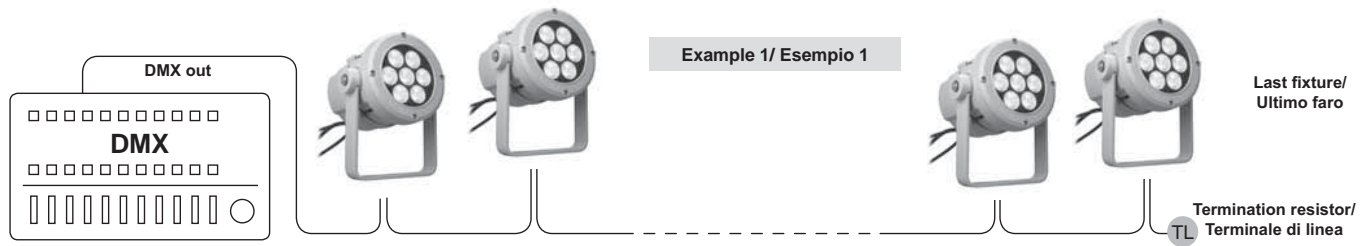

## NORMAL AND MASTER/SLAVE FUNCTIONS / FUNZIONI NORMAL E MASTER/SLAVE

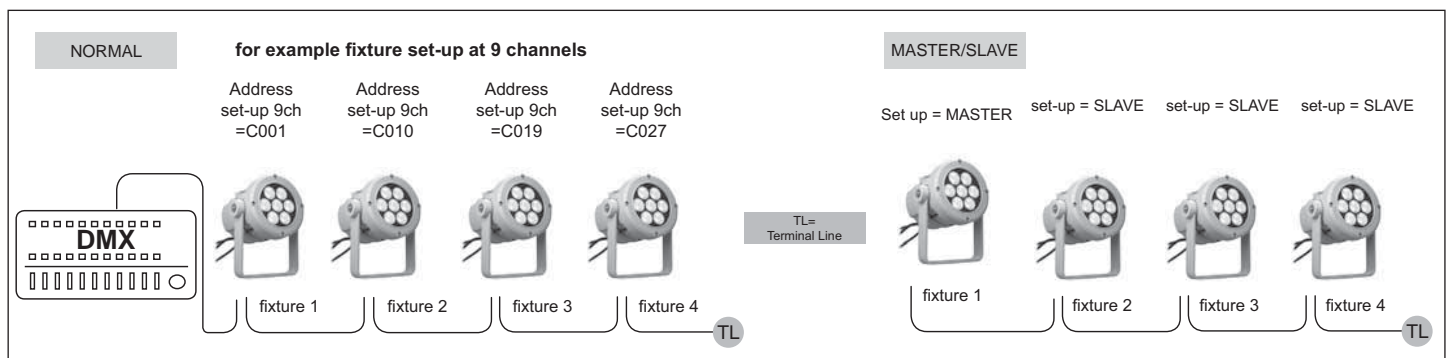



**CONNECTION TO THE MAIN POWER / CONNESSIONE ALLA RETE ELETTRICA**

**eng**

This equipment must be earthed.

Class I equipment. The power supply cord includes a protective earthing conductor as part of the cord.

**IMPORTANT:** to ensure the IP67 protection rating, in case of replacement of the conductor cable, refer to the CONDUCTOR SIZE TABLE

**ita**

Questo apparecchio necessita di messa a terra.

Apparecchio di Classe I. Il conduttore di protezione deve far parte del cavo di alimentazione.

**IMPORTANTE:** per garantire il grado di protezione IP67, in caso di sostituzione del cavo di alimentazione, fare riferimento alla TABELLA SEZIONE CONDUTTORE.

**⚠ WARNING**

**HIGH VOLTAGE!**

**Always disconnect the mains supply before access to the connection area.**

**ALTA TENSIONE!**

**Scollegare sempre l'alimentazione prima di aprire il vano dei collegamenti.**

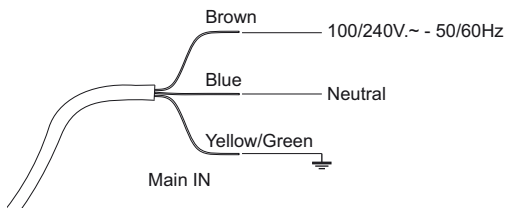

art. 1507 - 1509



**POWER INPUT/  
INGRESSO ALIMENTAZIONE Ø 6 - 12mm**

CONDUCTOR SIZES / SEZIONE CONDUTTORE (length / lunghezza < 20mt.)	
MAINS VOLTAGE	CROSS SELECTIONAL AREAS
230V	3X1 mm <sup>2</sup> (minimum)



## CONNECTION TO THE DMX LINE / CONNESSIONE ALLA LINEA DMX

eng

### DMX TERMINAL LINE

The wrong connection of the terminal line or its non-connection are probably the most frequent reasons for the defective functioning of the DMX line. The terminator is a terminal resistor fitted at the end of the cable furthest from the transmitter.

The terminal resistor should have the same value as the impedance of the connection cable.

We suggest to use a terminal with a 120 Ohm resistor.

It is recommended that all DMX 512 systems have the terminal resistor fitted in the DMX output of the last fixture.

ita

### TERMINALE LINEA DMX

L'incorretto o il mancato collegamento del terminale di linea è probabilmente la più comune causa del difettoso funzionamento della linea DMX. Il terminale di linea DMX consiste in una resistenza posta alla fine della linea.

La resistenza terminale dovrebbe avere idealmente lo stesso valore dell'impedenza del cavo di collegamento.

Noi consigliamo di usare come terminale una resistenza da 120 Ohm.

E' raccomandato per tutti i sistemi DMX 512 inserire il terminale di linea nel connettore uscita DMX dell'ultimo apparecchio collegato.

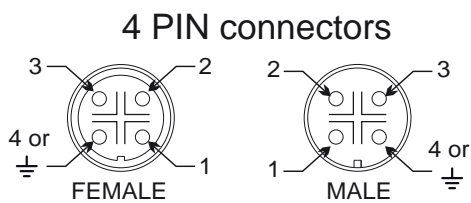

PIN	SIGNAL
1	GROUND/RETURN/OV
2	N.C.
3	DATA COMPLEMENT ( -, INVERTED)
4 or $\perp$	DATA TRUE ( +, NON INVERTED)

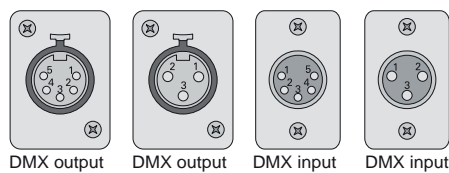

PIN	WIRE	SIGNAL
1	SHIELD	GROUND/RETURN/OV
2	INNER CONDUCTOR	DATA COMPLEMENT ( -, INVERTED)
3	INNER CONDUCTOR	DATA TRUE ( +, NON INVERTED)

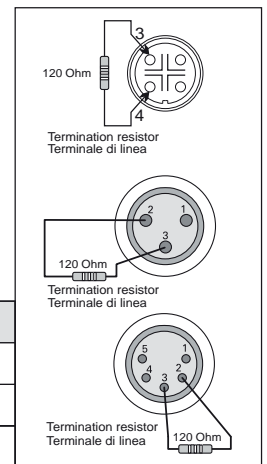

DMX IN (male)  
Ingresso DMX (maschio)

DMX OUT (female)  
Uscita DMX (femmina)









DMX IN (male)  
Ingresso DMX (maschio)

DMX OUT (female)  
Uscita DMX (femmina)





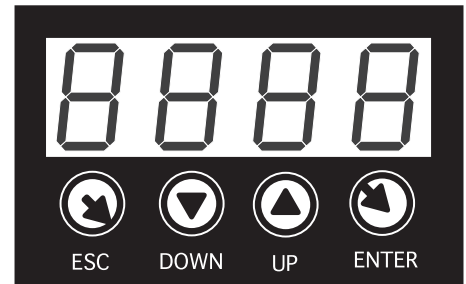

**DRS (DMX Remote Setup) FUNCTIONING**

To make the set-up of the various fixture parameter, proceed as follow:

- Disconnect the fixture to set-up from the other DMX/RDM devices
- Connect the DMX cable of the fixture to the DRS commander
-  Switch on the DRS commander and wait for the **8888** sign
-  If the DRS commander detects a compatible DRS device, displays shortly the **Conn** written and afterwards, displays the name of the fixture and its software version.
-  If the DRS commander don't detects any compatible DRS device or is present any malfunction, the display shows the **SCAn** written
-  When the detection sequence is finished, the display shows the first menu
-  The UP/DOWN buttons allow to scroll forward/backward the menu list
-  The ENTER button allow to confirm the selected option (if the parameter is flashing)
-  The ESC button allow to delete the operation and return to a previous menu level

**FUNZIONAMENTO DI BASE DEL DRS (DMX remote Setup)**

Per effettuare la programmazione dei vari parametri di un apparecchio, è necessario procedere come segue:

- Disconnettere l'apparecchio da configurare da altri dispositivi DMX/RDM
- Collegare il cavo DMX dell'apparecchio da configurare, al programmatore DRS
-  Accendere il programmatore DRS ed attendere che visualizzi la scritta **8888**
-  Se il programmatore DRS individua un dispositivo DRS compatibile, visualizza per qualche istante la scritta **Conn** e, successivamente, visualizza il nome dell'apparecchio e la relativa versione software
-  Se il programmatore DRS non individua alcun dispositivo DRS compatibile o è presente qualche malfunzionamento il display visualizzerà la scritta **SCAn**
-  Una volta terminata la sequenza di riconoscimento, viene visualizzato il primo menu dell'apparecchio
-  I pulsanti UP/DOWN permettono di scorrere la lista dei menu
-  Il pulsante ENTER permettere di entrare in un menu o di confermare una opzione in caso di lampeggio del parametro
-  Il pulsante ESC annulla una operazione o torna al livello di menu inferiore.

## MENU' LIST and BUTTON FUNCTIONS - ELENCO MENU' e FUNZIONI DEI PULSANTI



Switching on the fixture you can see the model and the software version. For example:  
All'accensione, viene visualizzato il modello di apparecchio e la versione software. Per esempio:

--> Studio Due ..... --> 1\_1 0 --> DMX channel --> C001

than it's shown the first DMX channel. When you press any button it's shown the first menu.

poi viene visualizzato il primo canale DMX. Quando si preme qualsiasi pulsante, viene visualizzato il primo menu.

- **UP**: scroll up into the menu / scorre in alto nel menu
- **DOWN**: scroll down into the menu / scorre in basso nel menu
- **ENTER**: enter into the menu/submenu (if present) / entra nel menu/sottomenu (se presente)
- **ESC**: exit from the menu/submenu / esce dal menu/sottomenu

**When the display flashing you always must press and hold 1 sec. ENTER to confirm the selected option.**

**Quando il display lampeggia dovete sempre tenere premuto per 1 sec. ENTER per confermare l'opzione scelta.**

### menu Address (Addr) > Set the DMX address / Imposta l'indirizzo DMX

AAAA press ENTER / premere ENTER

↳ 0000

> Select the channel number .. **c001** .. **c002** .. whit the UP/DOWN buttons. Press ENTER.

> Selezionate il canale desiderato .. **c001** .. **c002** .. con i tasti UP/DOWN. Premere ENTER.

### menu Display (dISP) > Display functions / Funzioni del display

DISP press ENTER for submenu / premere ENTER per i sottomenu

↳ FLIP (FLIP) 180° display rotate / Ruota di 180° il display

> Select the value **off** .. **on** whit the UP/DOWN buttons. Press ENTER.

> Selezionate il valore desiderato **off** .. **on** con i tasti UP/DOWN. Premere ENTER.

↳ brGt (brGt) Display brightness settings / Impostazioni luminosità del display

> Select the value **1** .. **7** whit the UP/DOWN buttons. Press ENTER.

> Selezionate il valore desiderato **1** .. **7** con i tasti UP/DOWN. Premere ENTER.

↳ LSHd (LSHd) Display shutdown settings / Impostazioni spegnimento del display

> Select the value **off** .. **on** whit the UP/DOWN buttons. Press ENTER.

> Selezionate il valore desiderato **off** .. **on** con i tasti UP/DOWN. Premere ENTER.

↳ LdMM (LdMM) Display dimmer (with active menu) / Dimmer del display (con menu attivo)

> Select the value **off** .. **on** whit the UP/DOWN buttons. Press ENTER.

> Selezionate il valore desiderato **off** .. **on** con i tasti UP/DOWN. Premere ENTER.



press ENTER for submenu / premere ENTER per i sottomenu

↳ **(Mode)**  
Set the DMX/SLAVE/MASTER mode / Imposta la modalità DMX/SLAVE/MASTER

- > Select the value **no .. sl .. pr01 .. pr02 ..** with the UP/DOWN buttons. Press ENTER.
- > Selezionate il valore desiderato **no .. sl .. pr01 .. pr02 ..** con i tasti UP/DOWN. Premere ENTER.

↳ **(SPd)**  
Set the preset execution speed / Imposta la velocità di esecuzione dei giochi interni

- > Select the value **+400% .. -400%** with the UP/DOWN buttons. Press ENTER.
- > Selezionate il valore desiderato **+400% .. -400%** con i tasti UP/DOWN. Premere ENTER.

↳ **(ScnE)**  
Enable or disable the use of a personal scene / Abilia o disabilita l'uso di una scena personale.

- > Select the value **ON .. OFF** with the UP/DOWN buttons. Press ENTER.
- > Selezionate il valore desiderato **ON .. OFF** con i tasti UP/DOWN. Premere ENTER.

If menu SCENE (ScnE) is enabled, it is possible to create a personal scene (you can create a custom color utilizing the menu which will appear below > RED, GREEN, BLUE, WHITE, WHITE BALANCE, varying the DMX values from 0 to 255 for each color)

Se il menu SCENE (ScnE) è attivo, è possibile creare una scena personale (potete creare un colore personalizzato utilizzando i menu che appariranno di seguito > RED, GREEN, BLUE, WHITE, WHITE BALANCE, variando i valori DMX da 0 a 255 per ogni colore)

↳ For each color or menu it is possible to varying and than set-up the value from 0 to 255 **without having to confirm** with the ENTER key. These functions are auto-save.

red



green



blue



white



white balance

Per ogni singolo colore o menu, è possibile variare e quindi impostare il valore da 0 a 255 **senza dover confermare** con il tasto ENTER. Queste funzioni si salvano automaticamente.

- > Select the single color with the UP/DOWN buttons. Press ENTER.
- > Selezionate il colore con i tasti UP/DOWN. Premere ENTER.

- > Select the value **0 .. 255** with the UP/DOWN buttons. Don't press ENTER.
- > Selezionate il valore desiderato **0 .. 255** con i tasti UP/DOWN. Non premere ENTER.

## menu Utility (UtlL) > Utility functions / Funzioni di utilità

 press ENTER for submenu / premere ENTER per i sottomenu

### (SMth)

Set the interpolation type for the smooth dimming function  
Imposta il tipo di interpolazione per la funzione smooth dimming



- > Select the value **1** .. **2** .. **3** .. **4** with the UP/DOWN buttons. Press ENTER.
- > Selezionate il valore desiderato **1** .. **2** .. **3** .. **4** con i tasti UP/DOWN. Premere ENTER.

### (hALo)

Set the alogen simulation function mode  
Imposta il funzionamento della modalità simulazione lampada alogena



- > Select the value **1** .. **2** .. **3** with the UP/DOWN buttons. Press ENTER.
- > Selezionate il valore desiderato **1** .. **2** .. **3** con i tasti UP/DOWN. Premere ENTER.

### (cyM)

Set the fixture to work in CYM or RGB emulation system  
Imposta l'apparecchio per funzionare come emulatore di sistema CYM o RGB  
(see DMX channels page - vedere pag. canali DMX)



- > Select the value **off** >> **RGB** or **on** >> **CYM** with the UP/DOWN buttons. Press ENTER.
- > Selezionate il valore desiderato **off** >> **RGB** or **on** >> **CYM** con i tasti UP/DOWN. Premere ENTER.

## menu Service (SrvC) > Service functions / Funzioni di servizio

 press ENTER for submenu / premere ENTER per i sottomenu

### (FrMt)

Restore the factory setting (Require confirmation) **FM-?**  
Ripristina le impostazioni di fabbrica (Viene chiesta conferma) **FM-?**



- > Select the value **off** .. **on** with the UP/DOWN buttons. Press ENTER.
- > Selezionate il valore desiderato **off** .. **on** con i tasti UP/DOWN. Premere ENTER.

### (tEst)

Enables the fixture test and execute a factory program to check the right functioning.  
Abilita il test dell'apparecchio ed esegue un programma di fabbrica per verificarne il funzionamento



- > Select the value **t-on** with the UP/DOWN buttons. T-on is flashing, the test is in progress. Press any key to exit.
- > Selezionate il valore desiderato **t-on** con i tasti UP/DOWN. T-on lampeggia, il test è in corso. Premere qualsiasi tasto per uscire.

### (nchn)

Set the DMX channels of the fixture / Imposta il numero di canali DMX dell'apparecchio



- > Select the value **9** .. **5** .. **4** with the UP/DOWN buttons. Press ENTER. (see DMX channel page)
- > Selezionate il valore desiderato **9** .. **5** .. **4** con i tasti UP/DOWN. Premere ENTER. (vedere pag. canali DMX)

**(FLcr)** Flicker free function / Funzione flicker free  
from 2.09 software version / dalla versione software 2.09



- > Select the value **f1** .. **f2** with the UP/DOWN buttons. Press ENTER.
- > Selezionate il valore desiderato **f1** .. **f2** con i tasti UP/DOWN. Premere ENTER.

**(ntc)** Service personnel only / Solo personale di servizio



\* WIRELESS MENU

this menu is present but can be edited if the optional art. WI DMX-REC (Wireless on board DMX 512 receiver) is installed on the fixture

\* MENU WIRELESS

questo menu è presente ma è editabile solo con l'accessorio art. WI DMX-REC installato sull'apparecchio (Ricevitore DMX 512 wireless)

**menu Wireless (WLSS) > Wireless functions / Funzioni wireless**

 press ENTER for submenu / premere ENTER per i sottomenu

↳  **(EnAb) Enable wireless**  
Enable or disable the wireless reception / Consente o non consente la ricezione wireless  
The cable reception is disabled / La ricezione via cavo viene disabilitata

- > Select the value **on** .. **off** .. with the UP/DOWN buttons. When the written is flashing, press ENTER.
- > Selezionate il valore desiderato **on** .. **off** .. con i tasti UP/DOWN. Quando la scritta lampeggia, premere ENTER.

↳  **(UnLn) Unlink transmission**  
Remove the link from the fixture to the associated transmitter / Elimina il link tra l'apparecchio e il trasmettitore al quale è stato associato

- > Select the value **on** .. **off** .. with the UP/DOWN buttons. When the written is flashing, press ENTER.
- > Selezionate il valore desiderato **on** .. **off** .. con i tasti UP/DOWN. Quando la scritta lampeggia, premere ENTER.

↳  **(brdG) Bridge function**  
If wireless is ON, enable the transmission of the received data by cable to the other fixtures / Se il wireless è attivo, consente la trasmissione dati agli altri apparecchi collegati via cavo.

- > Select the value **on** .. **off** .. with the UP/DOWN buttons. Press ENTER.
- > Selezionate il valore desiderato **on** .. **off** .. con i tasti UP/DOWN. Premere ENTER.

↳  **(Ln)**  
This menu will be active in the future / Questo menu sarà attivo in futuro

## DMX CHANNELS / CANALI DMX

### • 9 Channels mode • Modalità 9 Canali

CH1: Red  
CH2: Green  
CH3: Blue  
CH4: White  
CH5: Strobe  
CH6: Dimmer  
CH7: Led Fade Time  
CH8: Rainbow  
CH9: Fix White (Balanced White)

### • 6 Channels mode • Modalità 6 Canali

CH1: Red  
CH2: Green  
CH3: Blue  
CH4: White  
CH5: Dimmer  
CH6: Rainbow

### • 5 Channels mode • Modalità 5 Canali

CH1: Red  
CH2: Green  
CH3: Blue  
CH4: White  
CH5: Dimmer

### • 4 Channels mode • Modalità 4 Canali

CH1: Red  
CH2: Green  
CH3: Blue  
CH4: White

### • 9 Channels mode with CYM emulation • Modalità 9 Canali con emulazione CYM

CH1: Cyan  
CH2: Yellow  
CH3: Magenta  
CH4: Not used  
CH5: Strobe  
CH6: Dimmer  
CH7: Led Fade Time  
CH8: Rainbow  
CH9: Fix White (Balanced White)

### • 6 Channels mode with CYM emulation • Modalità 6 Canali con emulazione CYM

CH1: Cyan  
CH2: Yellow  
CH3: Magenta  
CH4: Not used  
CH5: Dimmer  
CH6: Rainbow

### • 5 Channels mode with CYM emulation • Modalità 5 Canali con emulazione CYM

CH1: Cyan  
CH2: Yellow  
CH3: Magenta  
CH4: Not used  
CH5: Dimmer

### • 4 Channels mode with CYM emulation • Modalità 4 Canali con emulazione CYM

CH1: Cyan  
CH2: Yellow  
CH3: Magenta  
CH4: Not used



### DMX Channels list 9Ch / Lista dei canali DMX 9Ch

8bit	FUNCTION	0 31 63 95 127 159 191 223 255									
		[Checkered bar]									
Ch1	RED	[Color gradient from black to red]									
Ch2	GREEN	[Color gradient from black to green]									
Ch3	BLUE	[Color gradient from black to blue]									
Ch4	WHITE	[Color gradient from black to white]									
Ch5	Strobe										
Ch6	Dimmer	[Color gradient from black to white]									
Ch7	Led fade time										
Ch8	Rainbow	[Rainbow color gradient]									
Ch9	Balanced white										

### DMX Channels list 6Ch / Lista dei canali DMX 6Ch

8bit	FUNCTION	0 31 63 95 127 159 191 223 255									
		[Checkered bar]									
Ch1	RED	[Color gradient from black to red]									
Ch2	GREEN	[Color gradient from black to green]									
Ch3	BLUE	[Color gradient from black to blue]									
Ch4	WHITE	[Color gradient from black to white]									
Ch5	Dimmer	[Color gradient from black to white]									
Ch6	Rainbow	[Rainbow color gradient]									

### DMX Channels list 5Ch / Lista dei canali DMX 5Ch

8bit	FUNCTION	0 31 63 95 127 159 191 223 255									
		[Checkered bar]									
Ch1	RED	[Color gradient bar from black to red]									
Ch2	GREEN	[Color gradient bar from black to green]									
Ch3	BLUE	[Color gradient bar from black to blue]									
Ch4	WHITE	[Color gradient bar from black to white]									
Ch5	Dimmer	[Color gradient bar from black to white]									

### DMX Channels list 4Ch / Lista dei canali DMX 4Ch

8bit	FUNCTION	0 31 63 95 127 159 191 223 255									
		[Checkered bar]									
Ch1	RED	[Color gradient bar from black to red]									
Ch2	GREEN	[Color gradient bar from black to green]									
Ch3	BLUE	[Color gradient bar from black to blue]									
Ch4	WHITE	[Color gradient bar from black to white]									

## DMX CHANNELS - CANALI DMX

- 3 Channels mode
- Modalità 3 Canali

CH1: Dimmer  
 CH2: Strobe  
 CH3: Fade

- 1 Channel mode
- Modalità 1 Canale

CH1: Dimmer

### DMX Channels list 3 Ch / Lista dei canali DMX 3 Ch

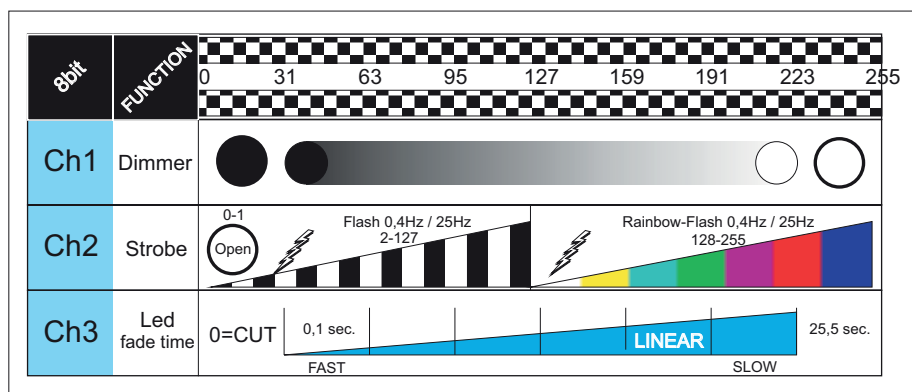

### DMX Channel 1 Ch / Canali DMX 1 Ch

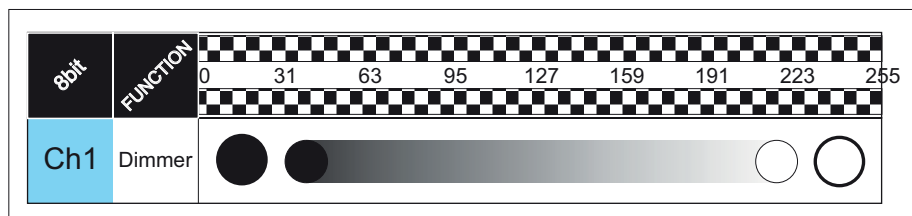

## BUILT IN PROGRAMS / LISTA DEI GIOCHI

Here below the list of 24 preset of the fixture.

Qui di seguito la lista dei 24 giochi presenti nell'apparecchio.

<b>Preset 1</b>	<b>Fixed RED</b>
<b>Preset 2</b>	<b>Fixed GREEN</b>
<b>Preset 3</b>	<b>Fixed BLUE</b>
<b>Preset 4</b>	<b>Fixed WHITE (w)</b>
<b>Preset 5</b>	<b>Fixed MAGENTA</b>
<b>Preset 6</b>	<b>Fixed YELLOW</b>
<b>Preset 7</b>	<b>Fixed CYAN</b>
<b>Preset 8</b>	<b>COLOR CHANGE FAST (Red, Green, Blue, Magenta, Yellow, Cyan, White) Color change no fade</b>
<b>Preset 9</b>	<b>COLOR CHANGE SLOW (Red, Green, Blue, Magenta, Yellow, Cyan, White) Color change with 2,5 sec. fade</b>
<b>Preset 10</b>	<b>RAINBOW SLOW</b>
<b>Preset 11</b>	<b>RAINBOW MID</b>
<b>Preset 12</b>	<b>RAINBOW FAST</b>
<b>Preset 13</b>	<b>WHITE BALANCE (from cool)</b>
<b>to .....</b>	<b>.....</b>
<b>Preset 18</b>	<b>WHITE BALANCE (to warm)</b>
<b>Preset 19</b>	<b>SIMULATION SODIUM lamps (yellow type)</b>
<b>to .....</b>	<b>.....</b>
<b>Preset 24</b>	<b>SIMULATION SODIUM lamps (yellow type)</b>

# PHYSICAL / DIMENSIONI

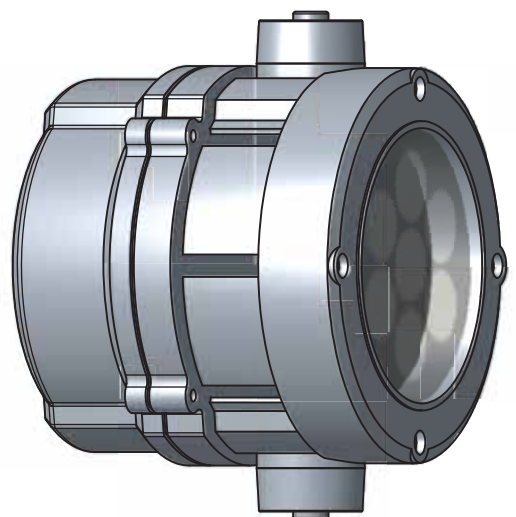
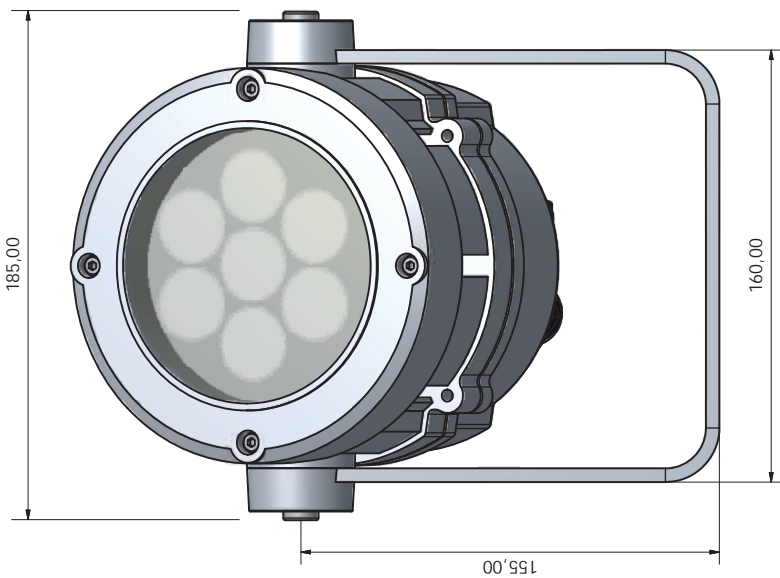
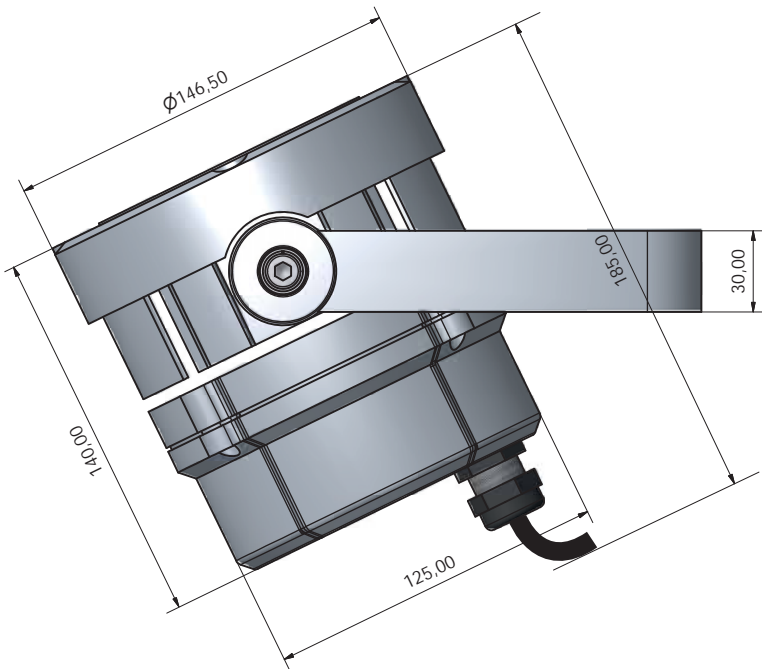
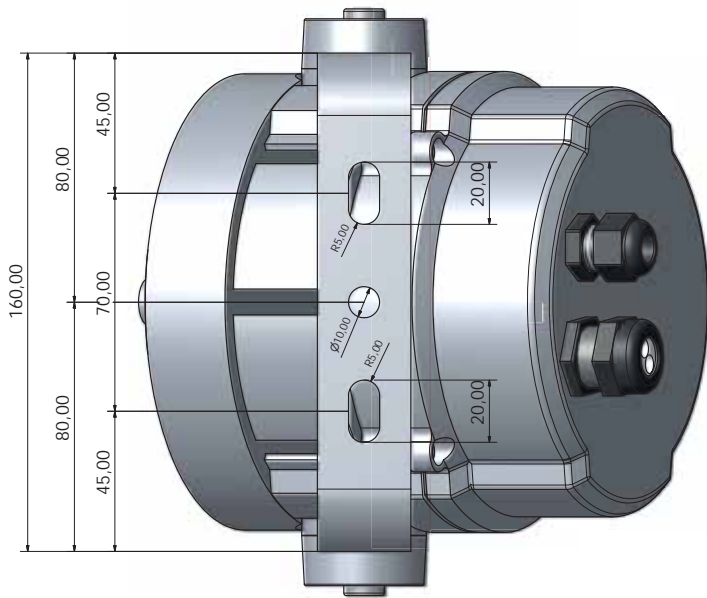

Dichiarazione CE di conformità Declaration CE of conformity

La ditta: STUDIO DUE light s.r.l.  
The firm: Strada Poggino, 100  
01100 VITERBO  
ITALY

dichiara sotto la propria responsabilità che il prodotto:  
declare under our sole responsibility that the product:

**PARLED 100/FC - RGBW/FC IP20**  
code 1506

è conforme alle norme: CE  
is in conformity with the standard: CE

#### Low Voltage Directive: 2014/35/EU

EN 60529:1991 + A1:2000 + A2:2013  
EN 62471:2008  
EN 60598-1:2015  
EN 60598-2-17:1989 + A2:1991

#### ECM Directive: 2014/30/EU

EN 61000-3-2:2014	EN 61000-4-2
EN 61000-3-3:2013	EN 61000-4-3
EN 61547:2009	EN 61000-4-4
EN 55103-2:2009	EN 61000-4-5
EN 55015:2013	EN 61000-4-6
EN 55103-1:2009 + A1:2012	EN 61000-4-11

e quindi ai requisiti essenziali delle Direttive:  
and therefore according to essential requirement of Directives:

2004/108/EC – Electromagnetic compatibility  
2006/95/EC – Low Voltage directive

Data di apposizione CE : 16  
Date of CE marking : 16

VITERBO, 18/05/16

PAOLO SENSI  
General Manager

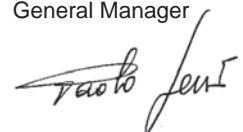



Dichiarazione  di conformità Declaration  of conformity

La ditta: STUDIO DUE light s.r.l.  
The firm: Strada Poggino, 100  
01100 VITERBO  
ITALY

dichiara sotto la propria responsabilità che il prodotto:  
declare under our sole responsibility that the product:

**PARLED 100/FC DRS - RGBW/FC IP67**  
code 1507

è conforme alle norme:   
is in conformity with the standard: 

**Low Voltage Directive: 2014/35/EU**



EN 60529:1991 + A1:2000 + A2:2013  
EN 62471:2008  
EN 60598-1:2015  
EN 60598-2-17:1989 + A2:1991

**ECM Directive: 2014/30/EU**

EN 61000-3-2:2014	EN 61000-4-2	CEI EN 61000-4-11
EN 61000-3-3:2013	EN 61000-4-3	CEI EN 55103-1
EN 61547:2009	EN 61000-4-4	CEI EN 55103-2
EN 55103-2:2009	EN 61000-4-5	
EN 55015:2013	EN 61000-4-6	
EN 55103-1:2009 + A1:2012	EN 61000-4-11	

e quindi ai requisiti essenziali delle Direttive:  
and therefore according to essential requirement of Directives:

2004/108/EC – Electromagnetic compatibility  
2006/95/EC – Low Voltage directive

Data di apposizione  : 16  
Date of  marking : 16

VITERBO, 18/05/16

PAOLO SENSI  
General Manager

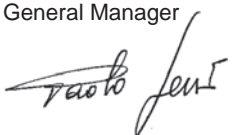

Dichiarazione CE di conformità

Declaration CE of conformity

La ditta: STUDIO DUE light s.r.l.  
The firm: Strada Poggino, 100  
01100 VITERBO  
ITALY

dichiara sotto la propria responsabilità che il prodotto:  
declare under our sole responsibility that the product:

**PARLED 100/M - Monochromatic IP67**  
code 1508

è conforme alle norme: CE  
is in conformity with the standard: CE

**Low Voltage Directive: 2014/35/EU**

EN 60529:1991 + A1:2000 + A2:2013  
EN 62471:2008  
EN 60598-1:2015  
EN 60598-2-17:1989 + A2:1991

**ECM Directive: 2014/30/EU**

EN 61000-3-2:2014	EN 61000-4-2
EN 61000-3-3:2013	EN 61000-4-3
EN 61547:2009	EN 61000-4-4
EN 55103-2:2009	EN 61000-4-5
EN 55015:2013	EN 61000-4-6
EN 55103-1:2009 + A1:2012	EN 61000-4-11

e quindi ai requisiti essenziali delle Direttive:  
and therefore according to essential requirement of Directives:

2004/108/EC – Electromagnetic compatibility  
2006/95/EC – Low Voltage directive

Data di apposizione CE : 16  
Date of CE marking : 16

VITERBO, 05/04/16

PAOLO SENSI  
General Manager

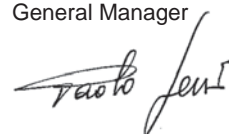



Dichiarazione CE di conformità

Declaration CE of conformity

La ditta: STUDIO DUE light s.r.l.  
The firm: Strada Poggino, 100  
01100 VITERBO  
ITALY

dichiara sotto la propria responsabilità che il prodotto:  
declare under our sole responsibility that the product:

**PARLED 100/M DRS - Monochromatic IP67**  
code 1509

è conforme alle norme: CE  
is in conformity with the standard: CE

**Low Voltage Directive: 2014/35/EU**

EN 60529:1991 + A1:2000 + A2:2013  
EN 62471:2008  
EN 60598-1:2015  
EN 60598-2-17:1989 + A2:1991

**ECM Directive: 2014/30/EU**

EN 61000-3-2:2014	EN 61000-4-2
EN 61000-3-3:2013	EN 61000-4-3
EN 61547:2009	EN 61000-4-4
EN 55103-2:2009	EN 61000-4-5
EN 55015:2013	EN 61000-4-6
EN 55103-1:2009 + A1:2012	EN 61000-4-11

e quindi ai requisiti essenziali delle Direttive:  
and therefore according to essential requirement of Directives:

2004/108/EC – Electromagnetic compatibility  
2006/95/EC – Low Voltage directive

Data di apposizione CE : 16  
Date of CE marking : 16

VITERBO, 05/04/16

PAOLO SENSI  
General Manager

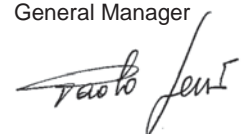

# Warranty CARD



Company name: .....

Mr./Mrs./Miss: .....

Address: .....

Tel. or E-mail : .....

Dealer: .....

## SALE CONDITIONS

1) Price quoted are not inclusive of lamp and package.

Package charge is 2% on the net price for all the items.

These prices should be subject to possible variations for eventual rises of production costs or duties.

Claims for possible damages during the freight, must be notified to the carrier.

Any claim must be notified within 8 days from the receipt of the goods.

The buyer is responsible of the right installation and use of the apparatus.

All the apparatuses are guaranteed for one year against defects of manufacture or materials.

Defects and breakages caused by wrong connection or use of the apparatuses are not subject to guarantee.

The lamp is excluded from the warranty.

For any dispute is competent the Tribunal of Viterbo.

## CONDIZIONI DI VENDITA

1) I prezzi riportati sono esclusi di IVA, lampada ed imballaggio.

Il costo di imballaggio è del 2% sul prezzo netto per tutti gli articoli.

Detti prezzi possono essere soggetti a possibili variazioni per eventuali aumenti dei costi di produzione o imposte.

La merce viaggia a rischio e pericolo del committente, anche se in porto franco.

Reclami per possibili danni durante il trasporto, dovranno essere fatti esclusivamente al vettore.

Eventuali osservazioni sulle merci ricevute dovranno esserci notificate entro e non oltre 8 giorni dal ricevimento delle medesime.

Sui ritardi dei pagamenti verrà conteggiato l'interesse commerciale.

L'acquirente si impegna a comunicare la propria esatta ragione sociale e partita IVA al momento dell'ordine e sotto la propria responsabilità di verificarla in fattura.

L'acquirente è responsabile della corretta installazione ed uso delle apparecchiature.

Tutte le apparecchiature godono della garanzia di un anno contro difetti di fabbricazione o di materiali, sono esclusi dalla garanzia danni derivanti da un cattivo uso o installazione delle apparecchiature.

Le lampade restano comunque escluse dalla garanzia.

Per ogni controversia è competente il Foro di Viterbo.

this page is intentionally left blank / questa pagina è stata lasciata intenzionalmente bianca

# Studio Due<sup>®</sup>

emotion and creativity in light

## **Head Office: STUDIO DUE s.r.l. (I)**

Str. Poggino, 100 - 01100 Viterbo (Italy)  
tel. +39.0761.352520  
fax +39.0761.352653  
info@studiodue.com

## **STUDIO DUE (UK)**

3 Encon Court Owl Close  
Moulton Park Industrial Estate  
Northampton England UK - NN3 6 HZ  
tel. +44.1933.650.820  
info@studiodue.co.uk

**www.studiodue.com**  
for technical info  
**service@studiodue.com**