

LUXI³EL

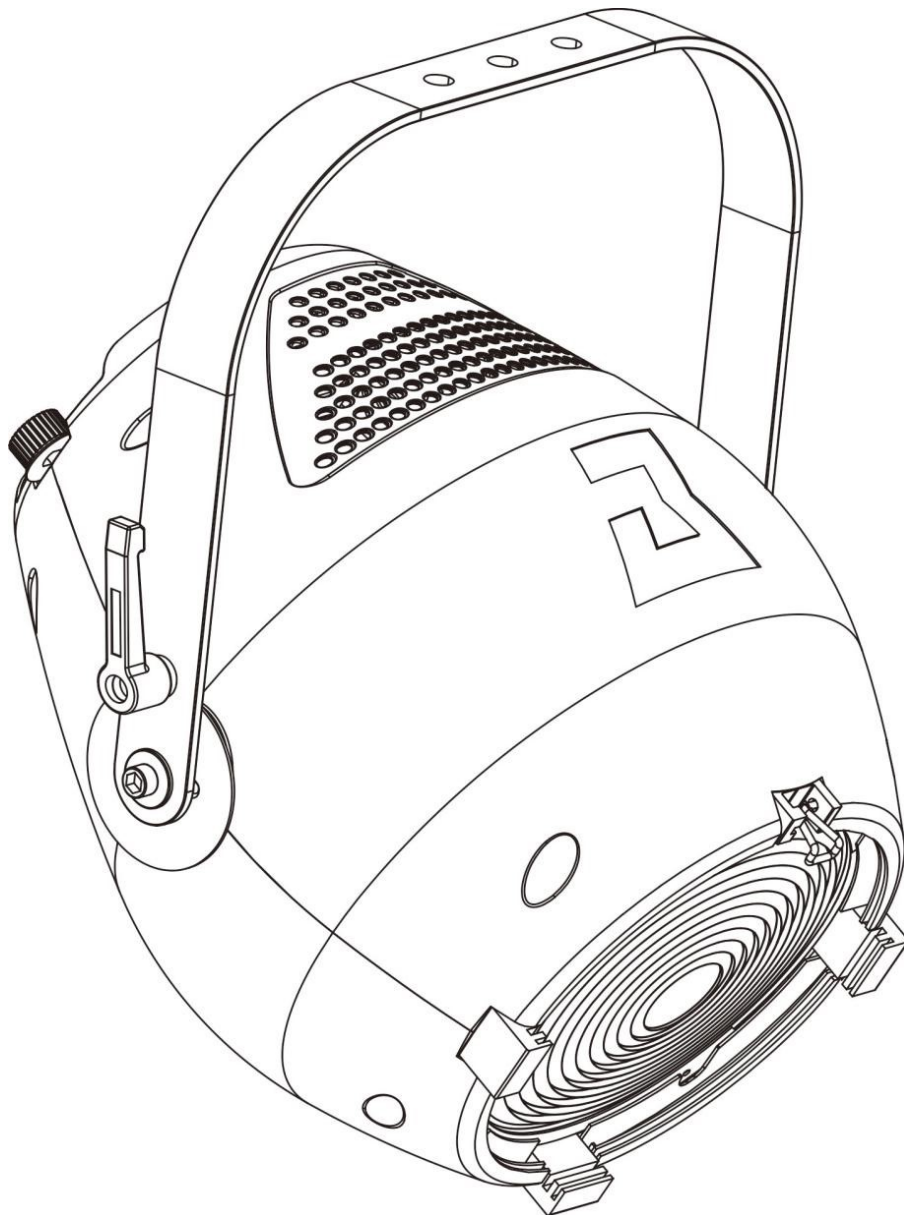

EXPO500TW

User Manual

Table of contents

Product introduction	3
Safety Notes	4
Maintenance	7
Installation	8
Control Menu	10
DMX Mode	11
Technical Specifications	13

Product introduction

Thank you for purchasing this Luxibel product.
 For your own safety, please read the instruction manual carefully before turn on the product for the first time.

Before unpacking the fixture, please make sure that the packaging is in good condition and that following items will be found in the box:

- B EXPO500TW fixture
- 3m DMX cable
- 1.5m power cable with powercon
- Safety chain

Description of the B EXPO500TW

1. Mounting bracket
2. Bracket tilt lock
3. B EXPO500TW
4. Barn door / filter frame
5. Ventilation holes
6. PowerTrue1 In
7. PowerTrue1 Out
8. OLED Menu Display
9. 5-Pin DMX In
10. Push turn Button
11. 5-Pin DMX Out

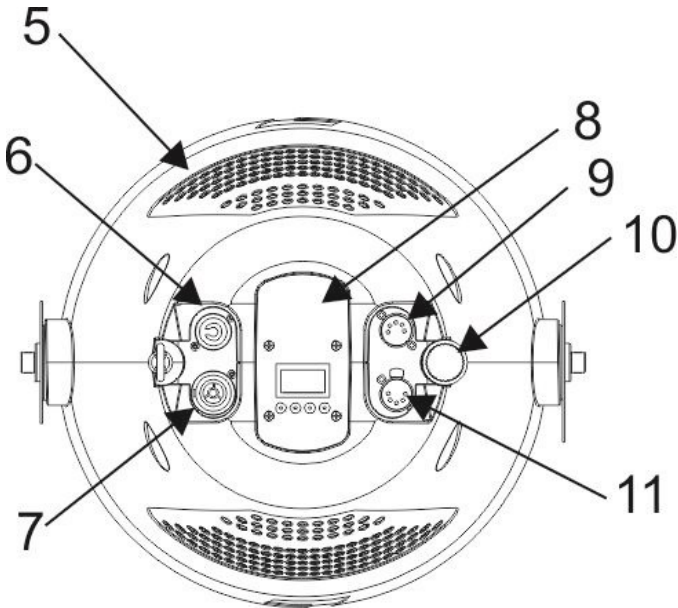
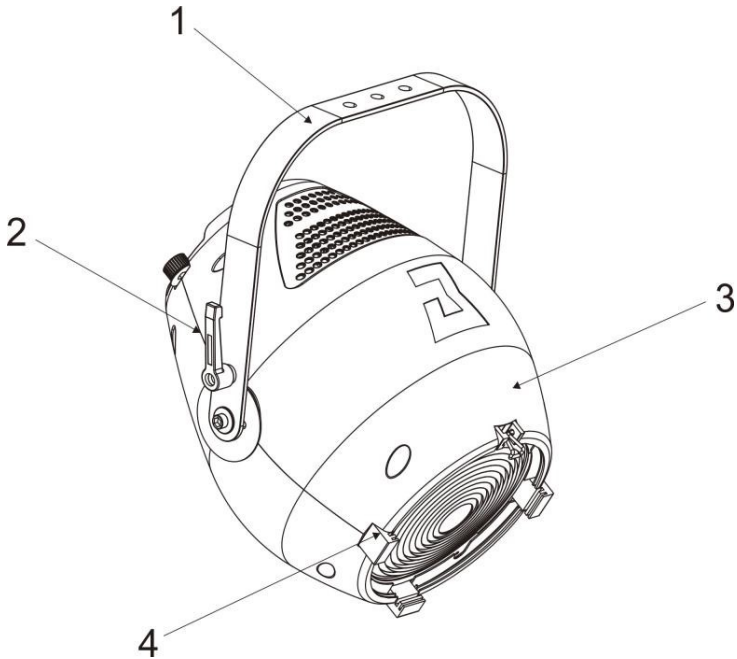

Safety Notes

Each person which is responsible for the installation, the usage of service of this unit must be qualified and has to follow the instruction in this manual.

Be careful when using the device. You risk an electrical shock from high voltage, if you touch the wires! The device has left our company in manufactured proofed state. To maintain this status and to ensure a permanent safe operation, it is absolutely necessary to follow the safety instructions and warnings in this manual.

Errors caused by not following these instructions are not covered by the warranty. The manufacturer will not accept liability for any resulting defects or problems.

- Keep the unit away from radiators or other heat sources!
- If the unit has been exposed to tremendous temperature changes (e.g. after transportation), do not turn the device on immediately. The resulting condensation could damage the unit. Don't switch the unit on until the device reaches room temperature.
- This device belongs to protection class I. Therefore, it is imperative that the green/yellow wire is connected to the earth contact or plug. The electrical connection must be made by a qualified person.
- Make sure that the cable has never been squeezed or damaged by sharp objects. Check the device and the cables regularly.
- If the cable is damaged, it must be replaced immediately by the manufacturer, its service agent or a qualified person in order to avoid danger.
- Lenses, glasses or UV filters must be replaced if they are visually damaged, or their effectiveness is impaired, e.g. by broken glass or by deep scratches.
- Ensure that wires never come in contact with other wires! Handle the power cord and all connections with caution!
- Make sure that the line voltage is not higher than the voltage specified in this manual.
- Disconnect the unit from the AC mains when it is not in use or when cleaning it. Disconnect the connection only by pulling the cable plug.
- Using the fixture for the first time, can result in light smoke and odors. This is a normal process and does not constitute a defect.

For a Class B digital device or peripheral, the instructions furnished the user shall include the following or similar statement, placed in a prominent location in the text of the manual:

NOTE: This equipment has been tested and found to comply with the limits for a Class B digital device, pursuant to part 15 of the FCC Rules. These limits are designed to provide

reasonable protection against harmful interference in a residential installation. This equipment generates, uses and can radiate radio frequency energy and, if not installed and used in accordance with the instructions,

may cause harmful interference to radio communications. However, there is no guarantee that interference will not occur in a particular installation. If this equipment does cause harmful interference to radio or television reception, which can be determined by turning the equipment off and on, the user is encouraged to try to correct the interference by one or more of the following

measures:

- Reorient or relocate the receiving antenna.
- Increase the separation between the equipment and receiver.
- Connect the equipment into an outlet on a circuit different from that to which the receiver is connected.
- Consult the dealer or an experienced radio/TV technician for help.

Risk of burns!

Do not touch the unit during operation! The housing may reach high temperatures!





Risk to health!









Never look directly into the light source. Especially epileptics risk an epileptic shock. Disconnect the unit from the AC mains when not in use or when cleaning it.

Defects caused by modifications of the device by unqualified handling or an unqualified person are not covered by the warranty.

Keep the product away from children and unskilled people.

There are no wear parts in the device. Maintenance and service must be performed only by an authorized service partner.

	Before operate this unit, please carefully read this users guide and keep if needed in future. It's necessary to respect following rules.
	The disposal of the device after lifecycle could damage the environment, need to take it to special company for recycling or return to authorized dealer.
	The products referred to in this manual conform to the European Community Directives and are therefore marked with CE logo.
	Keep this device away from children and unauthorized users, the manufacturer will not take responsibility for the damage due to any disregard of the information provided in this manual and wrong operation.
	Before operate the device, please make sure the fixture is in good housing, ensure pan and tilt can rotate in its complete range.
--0.5m	Please make sure minimal 0.5m distance need to kept between the fixture to any flammable material.

	<p>The device can only run with 100-240V voltage, 50/60 Hz power, don't connect to any other wrong power. Disconnect the device from main power before open the shield or maintenance.</p>
	<p>The device is designed only for indoor usage, please keep it away from moisture. Do not expose the device under the sun or directly to any other lighting source.</p>
	<p>Never look directly into the projecting lens when the fixture is power on, the light may trigger epileptic seizures in photosensitive persons or persons with epilepsy. Especially at beam effect, extreme caution and observance of these safety instructions is mandatory.</p>
	<p>Don't put or install the device on a surface that subject to vibration or bumps.</p>
<p>Ta=45°C</p>	<p>The device is supposed to work in the temperate range -15° C and +45° C, do not use the device when the temperate exceed this range.</p>
	<p>The lens, shield need to be replaced when obviously broken, never use the device when the shield is not completed closed.</p>
	<p>Safety I class device, need to be earth connected.</p>
	<p>When the fixture is hanged overhead, the safety rope must be fixed to the bottom of the device to the appropriate fixing point.</p>
	<p>Always carry the device by the bracket, do not take the head directly for transportation.</p>

Maintenance

Operation only allowed to qualified person, damages due to unprofessional operation or remove of any parts inside will not be considered in warranty service. There are no serviceable parts inside the device or package, service only leaves to authorized dealers.

Never allow the optical components contact with oil, fat or any other liquid.

A regular clearance of the device is needed for long-term usage, this is very helpful to maintain the lifetime and brightness need to use a soft and lint-free cloth to clean the optical system, fan and air flowing tunnel.

Trouble shooting

Problems	Possible reasons	Solutions
Device not power up	Powercon or power cable damaged Faulty power supply	Change a good power cable to try Replace new power supply
LED off	Temperature protection Fan not working Faulty LED Dimmer and strobe set at 0 Faulty power supply	Check the temperature from menu Check the fan speed info from menu Replace new LED Set dimmer channel at 255 and strobe channel at 0~5 Replace new power supply
Device not response to DMX	Faulty communication IC Faulty display PCB Wrong DMX addressing Faulty DMX cable	Replace the IC with back-up one in the display PCB Replace new display PCB Check the address and setting Change to a good DMX cable
Fans not working properly	Head cover is pushing up to the fan and hereby blocking movement	Check if it's possible to unblock the fan Replace head cover
Light goes out	One or more fans are not working properly	Set Fan mode to high, now check in information the fan speed this cannot be close to 0, if this is the case: Check if the fan is blocked Check the fan cable connections

Replacement of the fuse

- Step 1: Unplug power cable from main power
- Step 2: Unscrew the fuse holder out of the housing with a screwdriver
- Step 3: Remove the broken fuse and replace with an exact same type of new fuse
- Step 4: Insert the fuse holder back to the housing and screw tight and reconnect power

Installation

There are specific regulations like BGV C1 (old VBG 70) or country related regulations which need to attend during the installation. The installation has to be handled by skilled persons only!

Suspension device has to be built and calculated in order to handle up to 10 times its specific load limit over a time of one hour without permanent or harmful deformation.

Installation has to be done with a separate, independent suspension device like a safety chain. A second suspension device has to be built in order to assure that in case of error no part of an installation can fall off.

Trespassing the danger zone below the installation during the assembling is prohibited.

Installer has to take care of all safety and machinery installations are approved by authorized persons before first operation or after changes before restarting.

Installer has to take care of all safety and machinery installations are approved by skilled persons at least once a year.

Installer has to take care of all safety and machinery installations are approved by authorized persons every four years during the acceptance inspection. Spotlight should ideally installed outside peoples lounge area.

Attention

Installation overhead needs a high level of experience. This includes (but is not just limited to) calculation and definition of load capacity, used installation material and regular safety inspections of used material and the fixture itself. Never try to do the installation by yourself if you are not qualified, instead you have to instruct a skilled installer. Inappropriate installations can cause injuries and/or damage of property. Spotlight has to be installed outside areas where people can touch it.

Professional truss system or similar licensed suspension systems have to be used if the spotlight is used in suspension from ceiling or other constructions. Spotlights can never be installed freely suspended!

Spotlights can cause injuries when fall off. If you are not trained in questions of safety for the different kinds of installation do NOT install the spotlight! Assure that the mounting surface can hold at least ten times the point load of the spotlight before installing the fixture.

Assure the specified safety distances to flammable material.

Attach the spotlight with its yoke and the use of a suitable hook/clamp to your truss system. The therefor used opening has a diameter of about 12 mm. According to your installation also similar but approved suspension devices are possible.

When installing the spotlight overhead make sure to safe the fixture by a safety chain which is specified at least with a load limit of 12 times of the spotlights weight. Only safety chain with approved connective can be used. Attach the safety chain to its designated opening and attach it to the truss system or a similar and safe attachment point. Assure to close the fasteners as specified.

To adjust the angle of the fixture open the locking screw, set the fixture in its position and close it by hand.

Installation of the B EXPO500TW

The device could be either put on a solid and even surface, or mounted upside down or sideways like left picture.

The mounting place must be sufficient stable and be able to support a weight of 10 times of the unit's weight. When the fixture is hanged, always additionally secure the device with the safety chain, fasten the safety rope at a suitable position so that the maximum fall of the projector will be 20 cm.

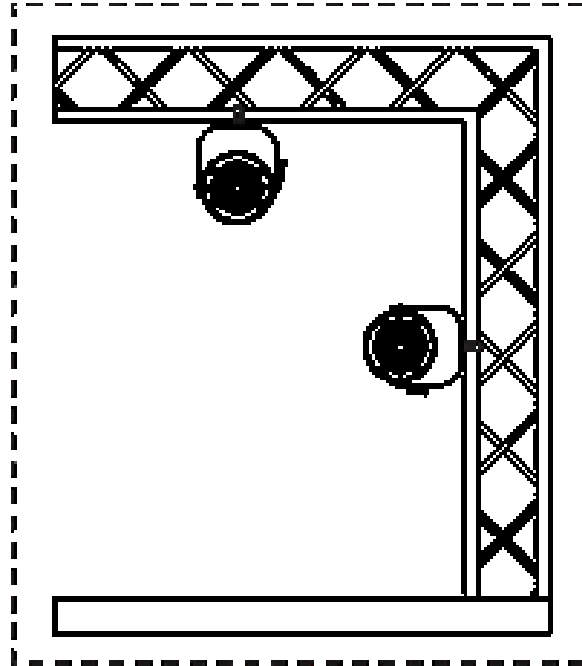
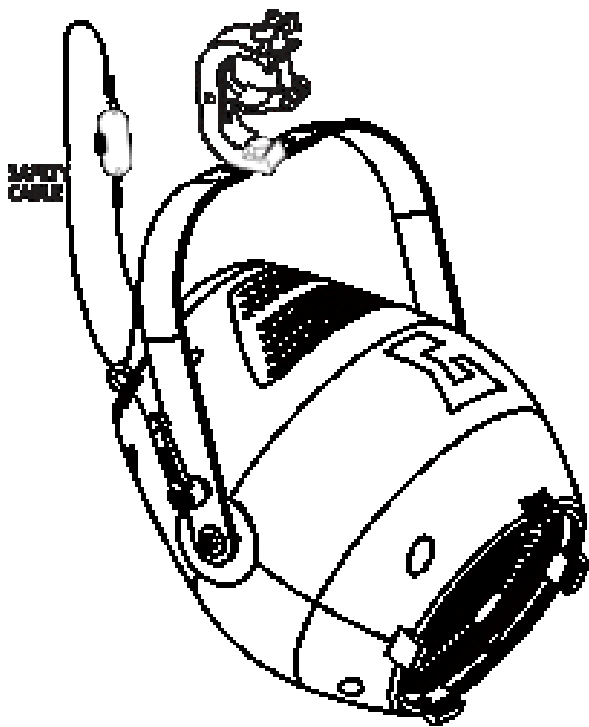

Control Menu

Menu tree

Default settings shadowed.

Model Name: B EXPO500TW				
DMX	DMX Addr①	XXX		
	DMX mode①	3CH / 4CH / 7CH		
Manual Control	Max Temp①	80~130°C/176~266°F (85°C)		
	Dimmer			
	DimmerFine			
	CCT			
	Zoom			
	Strobe			
Information	Lamp Temp			
	Fan Speed	FAN1: XXXR		
		FAN2:XXXR		
		FAN3: XXXR		
Soft version				
Settings	Fixture Set	Temper. C/F①	Fahrenheit /Celsius (Celsius)	
		Fans Mode①	Auto/Silent/High	
		Backlight①	01~300s (10s)	
		Flip Display①	ON/OFF (OFF)	
	Rdm settings	Name		
		Rdm Mode	Mode1/mode2	
		-Password-		
		PID Code		
	Freq rate	600Hz		
		1200Hz		
		2000Hz		
		2400Hz		
		4000Hz		
		16KHz		
		18KHz		
Reload Def	Basic Reload(①)	ON/OFF (OFF)		
	---Password---	XXX		
	All Reload	ON/OFF (OFF)		

DMX Mode

DMX addressing

The device is controlled by universal DMX 512 protocol, DMX address is the start channel used to receive instructions from the external controller. For independent control, each fixture must be assigned its unique address control channels. For example, this device has four channel modes: 20/21/15/17, if we set the mode at standard 18 channels mode, and there are several models need to be independently controlled, we just simply address first fixture at 1, and second fixture at 21, third one at 41, etc.

If the devices have the same address, they will behave synchronically.

DMX addressing is limited, don't set the address so high that without enough control channels for the fixtures.

Display is flashing when no DMX signal is received.

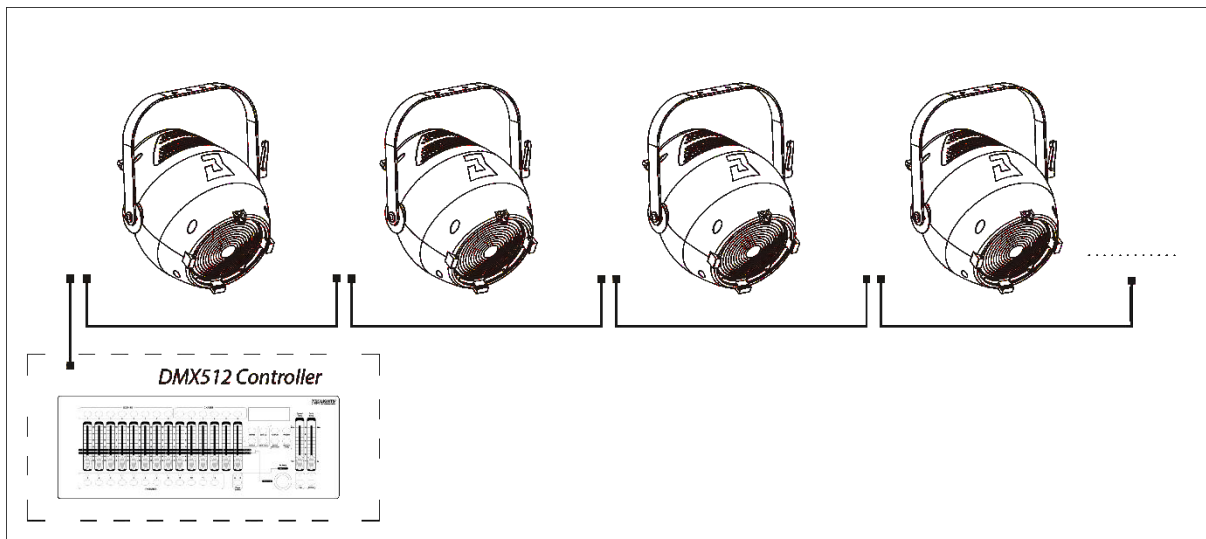

Connection

Use DMX cable with 5-pin XLR-plugs to connect the controller with the fixture or one fixture with another.

5.1.2 This device is equipped with 5-pins DMX in and out sockets only.



Pin1 =GND Pin4 =N.A.
Pin2=SIG(-) Pin5=N.A.
Pin3=SIG(+)

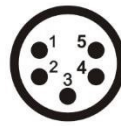

5.1.3 The termination is prepared by soldering a 120Ω resistor between pins 2 and 3.

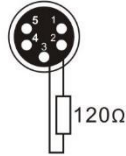

Unique features

RDM, stand for “Remote Device Management”, with this function, users can realize remote control of the device, such as remotely changing DMX address, check a lot of useful information such as temperature, power consumption, fan speed. Etc. Every single device has a unique RDM code before left factory to distinguish from each other, usually not suggest users change this code freely.

Software upgrade function via DMX cable, if there is any new firmware for this device come out, it can be upgraded simply via a software upgrade box, no need to change any mechanical parts. The upgrade box is not included in the package, if need any further assistance please just contact authorized dealers.

Hibernation, the device will enter sleeping mode if activated after a period of disconnecting DMX signal to save the power consumption, and will return immediately as soon as the DMX signal is sent again.

Display battery, this function is prepaid in the display PCB, users just need to install a normal 10440 600mAh 3.7V rechargeable lithium battery, then users could power on the display and do setting without connect to main power.

Display back-up communication IC, there is a back-up communication IC installed in the display PCB, so users could replace at once if the working one is broken, no need to wait long time from service.

Display flip, by press up and down button for more than 3 seconds, the display will flip automatically, this function is useful to read menu conveniently when device is hanged.

Technical Specifications

Dimensions drawing

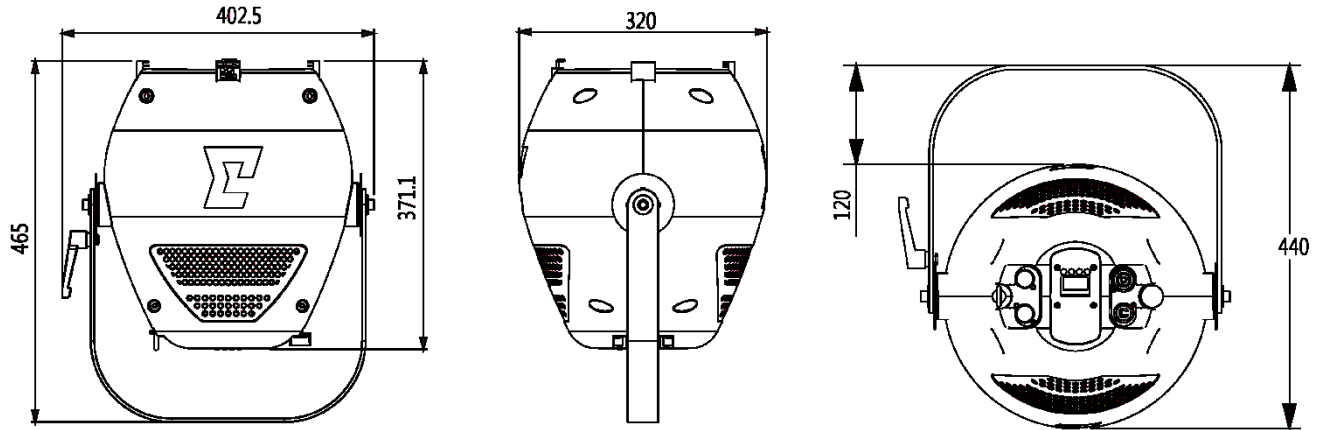

Physical

Dimensions (WxHxD): 46,7 x 40,4 x 32,0 cm | 18,4" x 15,9" x 12,6"

Packaging dimensions (WxHxD): 51,1 x 43,9 x 38,6 cm | 20,1" x 17,32" x 15,16"

Net weight: 11 kg | 24,3 lbs

Gross weight: 12 kg | 26,5 lbs

Mounting options

Hanging: 3x M12 hole

Standing: n/a

2nd suspension / safety wire

1x eye in back of unit to pass carabiner

Control

Menu control: TFT display with 4 buttons

Control: DMX512, manual

In/Link: XLR 5-pin

DMX Mode: 3/4/7 channels

16-bit dimming

1-hand locking

Optical

Lamp type: LED fresnel
Beam angle: 21° - 55°
Colours: 2.700K – 6.200K
Refresh rate: adaptable 600 Hz – 4000 Hz
Strobe: 0-20 Hz
CRI: 97.4 ra
TM30: Rf = 95 – Rg = 101
TM30: Rf = 95 – Rg = 101

Photometric data B Expo500TW (WW)

Light output @ 21°
Lux @ 5m: 3020 lux
Lux @ 10m: 900 lux
Lux @ 15m: 420 lux
Light output @ 55°
Lux @ 5m: 708 lux
Lux @ 10m: 230 lux
Lux @ 15m: 115 lux

Photometric data B Expo500TW (CW)

Light output @ 21°
Lux @ 5m: 4720 lux
Lux @ 10m: 1200 lux
Lux @ 15m: 580 lux
Light output @ 55°
Lux @ 5m: 1100 lux
Lux @ 10m: 310 lux
Lux @ 15m: 160 lux

Electrical

Fixture rated power: 300W
LED engine: 500W Tunable white
Input power: 100 - 240V ~ 50/60Hz Auto switching power supply
In/Link: PowerCon TRUE 1 / max. link current 10A

Environmental

Cooling: Heat pipe + air cooling
IP rating: IP20

Contact

Luxibel

Bedrijvenpark De Veert 13/004

2830 Willebroek

Belgium +32 3

860 76 50

info@luxibel.com

www.luxibel.com